



# General AC Drive **G100**

3-phase 200~240V 0.4~7.5kW (0.5~10HP)  
3-phase 380~480V 0.4~7.5kW (0.5~10HP)



# LSIS

## Contents

- 04 Features
- 10 Model & Type
- 11 Specifications
- 13 Wiring
- 14 Power Terminal
- 15 Control Terminal
- 16 Keypad Functions
- 22 Parameter Group
- 46 Peripheral Devices
- 47 Drive Watt Loss Data
- 48 Dimensions



# General Drive **G100**

new





The G100 is the solution for general drives applications because of its high performance sensorless operation, premium quality and high reliability.

### Great Reliability

- Meets UL 61800-5-1
- Military (MIL 217Plus) design based methodology
- Enhanced materials and manufacturing processes

### Great Performance

- Enhanced motor control-sensorless & V/F performance
- User-friendly-easy tuning sensorless control
- Suitable for most applications

### User Friendly

- Easy to install, use and maintain
- Various options



## Great Reliability

G100 is designed to meet global standards through upgraded design, materials and manufacturing improving its endurance for harsh environments.

### UL 61800-5-1<sup>1)</sup> Design

Satisfied the new UL certification

<sup>\*1)</sup> After February 2020 all of system, product have to satisfy new UL certification

### Robust Design

Construction of the air flow design minimizes exposure of critical components (IGBT, PCB, etc.) from outside contaminants.

### Built-in EMC Filter

Embedded C3 EMC filter to meet EN618000-3 standards and provide noise reduction



### Fan Lifecycle Diagnosis

Display fan replacement warning message with digital output or keypad

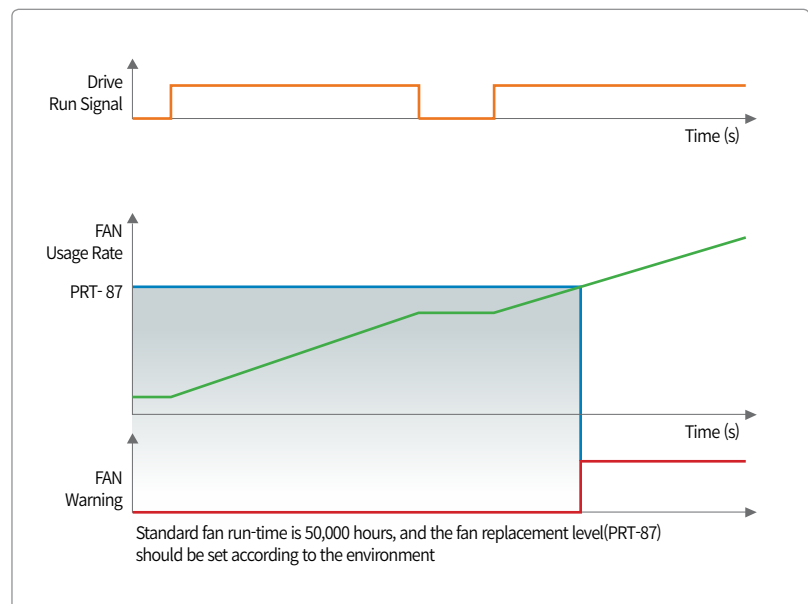

### MIL217Plus based Design

- Reliability design basis tool (PSA, Fr-FMEA, FTA, RBD, PBS)
- Improved circuit robustness through strict quality margins

Category	G100
Estimated Life Cycle	240,455 hrs(27 yrs) (Accelerated life test result : 295,951 hrs)
Reliability Test Method	MTTF
Standard	MIL-HDBK-217F RIAC HDBK 217Plus
Ambient Temperature	30°C (86°F)

### Material Design

- Enhanced thermal resistance and intensity through upgraded materials
- Increased thickness to prevent damage

## Features



## Great Performance

The G100 has an advanced sensorless vector mode along with a highly adaptable V/F mode making it one of the most versatile drives on the market.

### Application Adaptability

Dual ratings enable use in most applications

### V/F Accelerate and Decelerate Function

Applied ATB & Flux braking function

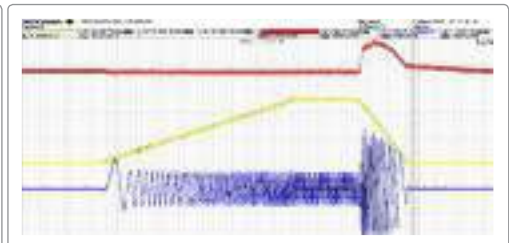
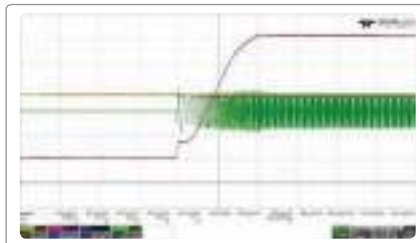



### Sensorless Performance

- Low speed/High torque
- Tight speed regulation +/- 1%
- 0.5Hz 200% peak torque

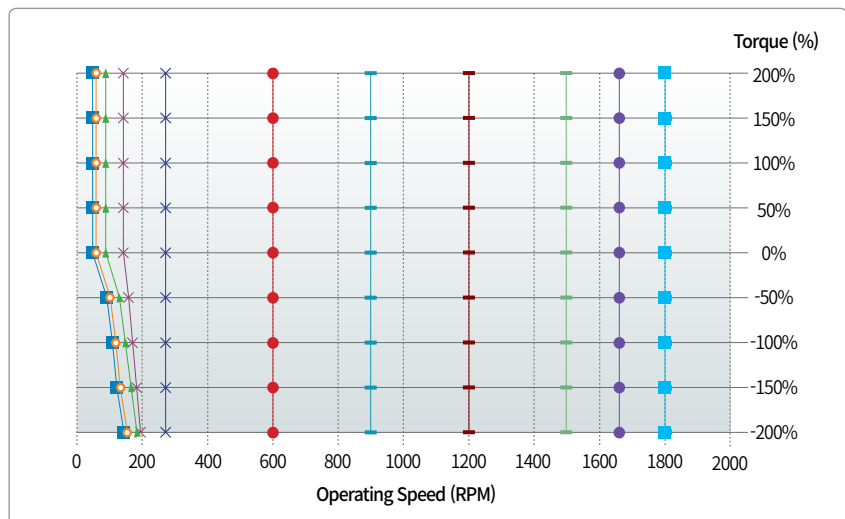
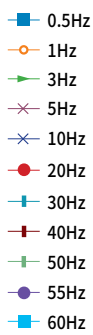

### KEB (Kinetic Energy Buffering)

- KEB for a stable system stop in case of power loss or failure.
- Select KEB operation function for different speeds and purposes

### Flying Start

Select optimal flying start operation for different applications

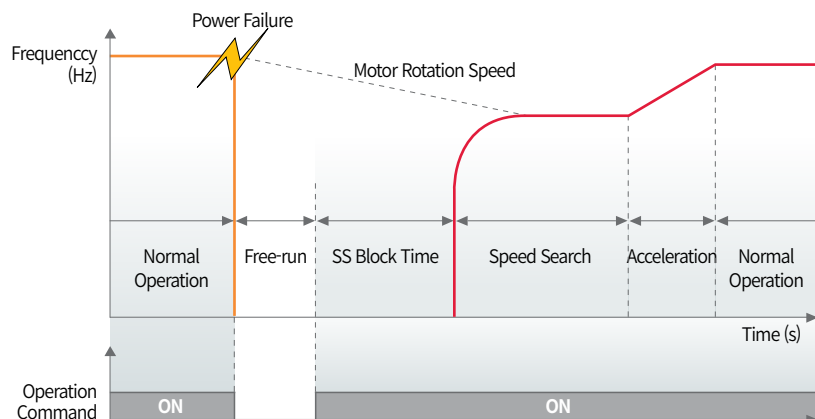



## User-friendly Design

**G100 is convenient to install, control, perform maintenance and many other functions.**

**1 Built-in Potentiometer**

Easy operation with built-in potentiometer

**2 Smart Copier**

Copy parameter (Read/Write) and download firmware without supplying power to drive

**2 Remote Keypad**

Copy parameter (Read/Write) using remote keypads





## 2 Fieldbus Options

Provides various communication options with simple mounting structure

- Dual Port EtherNet/IP
- Profibus-DP
- CANopen



## 2 PC Tools (DriveView 9)

New version of PC tool

## 2 Easy Modbus Communication Connection

2 type of connection of Modbus communication

- RJ45 Port
- I/O (S+, S-)

## 3 QR Code



View manuals and various information from the QR code printed on the front cover.



## 4 Built-in 2 Relay

Cost efficient and easy to compose system with two embedded relays.



## 5 DIN rail Mount (Below 4kW)

Install using DIN rails (Side-by-side)



## 6 Fan Replacement

Simple cooling fan replacement procedure



## 7 I/O Terminal (5mm)

Easy wiring with 5mm I/O pitch

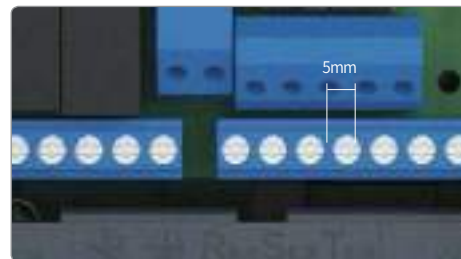

## 8 Operation Group

- Access commonly used parameters in the operation group
- Identical Parameter group structure for all 100 series

## 8 100 Series Parameter Group Configuration Applied

Motor rating	3-Phase 200V	3-Phase 400V
0.4 kW	LSLV0004G100-2E0NN	LSLV0004G100-4E0(F)N
0.75 kW	LSLV0008G100-2E0NN	LSLV0008G100-4E0(F)N
1.5 kW	LSLV0015G100-2E0NN	LSLV0015G100-4E0(F)N
2.2 kW	LSLV0022G100-2E0NN	LSLV0022G100-4E0(F)N
4.0 kW	LSLV0040G100-2E0NN	LSLV0040G100-4E0(F)N
5.5 kW	LSLV0055G100-2E0NN	LSLV0055G100-4E0(F)N
7.5 kW	LSLV0075G100-2E0NN	LSLV0075G100-4E0(F)N
11 kW		
15 kW		
18.5 kW		
22 kW		

※ (F): Built-in EMC or Non-EMC type  
 ※ 200V/400V 11~22kW TBA

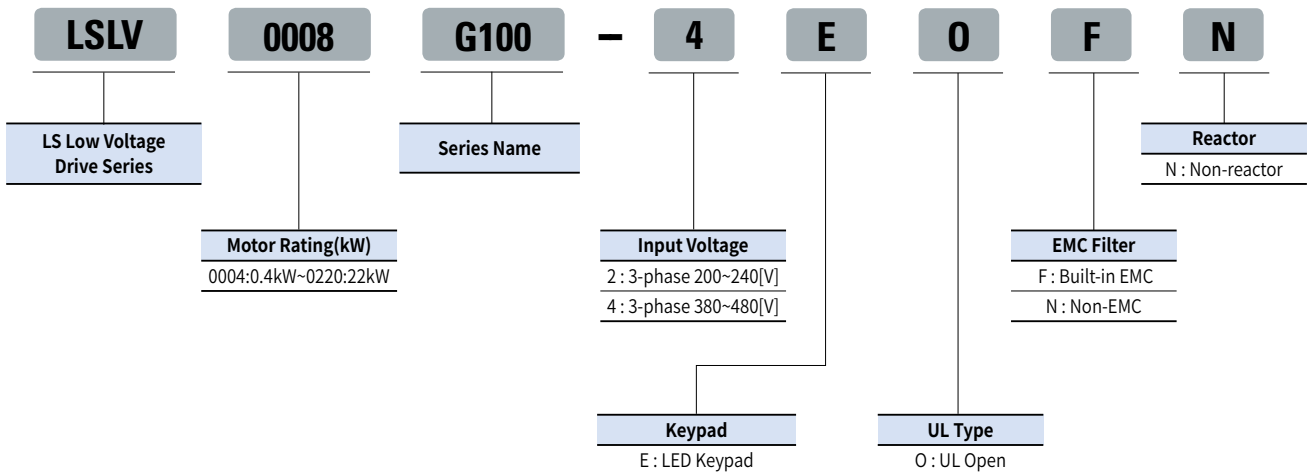

## 3-Phase 200V Class (0.4~7.5kW)

□□□□ G100-2			0004	0008	0015	0022	0040	0055	0075	
Motor Rating	Heavy Duty (HD)	(HP)	0.5	1.0	2.0	3.0	5.4	7.5	10	
		(kW)	0.4	0.75	1.5	2.2	4.0	5.5	7.5	
	Normal Duty (ND)	(HP)	1.0	2.0	3.0	5.4	7.5	10	15	
		(kW)	0.75	1.5	2.2	4.0	5.5	7.5	11	
Output Rating	Capacity [kVA]	Heavy Duty (HD)	1.0	1.9	3.0	4.2	6.5	9.1	12.2	
		Normal Duty (ND)	1.2	2.3	3.8	4.6	6.9	11.4	15.2	
	Rated Current (3-Phase Input) [A]	Heavy Duty (HD)	2.5	5.0	8.0	11.0	17.0	24.0	32.0	
		Normal Duty (ND)	3.1	6.0	9.6	12.0	18.0	30.0	40.0	
	Rated Current (1-Phase Input) [A]	Heavy Duty (HD)	1.5	2.8	4.6	6.1	9.3	12.8	17.4	
		Normal Duty (ND)	2.0	3.6	5.9	6.7	9.8	16.3	22.0	
	Frequency [Hz]	0~400Hz (IM sensorless: 0~120Hz)								
Voltage [V]	3-Phase 200~240V									
Input Rating	Voltage [V]	3-Phase 200~240VAC (-15%~+10%)								
	Frequency [Hz]	50~60Hz (±5%)								
	Rated Current [A]	Heavy Duty (HD)	2.2	4.9	8.4	11.8	18.5	25.8	34.9	
Normal Duty (ND)		3.0	6.3	10.8	13.1	19.4	32.7	44.2		
Weight [kg]			1.04	1.06	1.36	1.4	1.89	3.08	3.21	

## 3-Phase 400V Class (0.4~7.5kW)

□□□□ G100-4			0004	0008	0015	0022	0040	0055	0075	
Motor Rating	Heavy Duty (HD)	(HP)	0.5	1.0	2.0	3.0	5.4	7.5	10	
		(kW)	0.4	0.75	1.5	2.2	4.0	5.5	7.5	
	Normal Duty (ND)	(HP)	1.0	2.0	3.0	5.4	7.5	10	15	
		(kW)	0.75	1.5	2.2	4.0	5.5	7.5	11	
Output Rating	Capacity [kVA]	Heavy Duty (HD)	1.0	1.9	3.0	4.2	6.5	9.1	12.2	
		Normal Duty (ND)	1.5	2.4	3.9	5.3	7.6	12.2	17.5	
	Rated Current (3-Phase Input) [A]	Heavy Duty (HD)	1.3	2.5	4.0	5.5	9.0	12.0	16.0	
		Normal Duty (ND)	2.0	3.1	5.1	6.9	10.0	16.0	23.0	
	Rated Current (1-Phase Input) [A]	Heavy Duty (HD)	0.7	1.4	2.1	2.8	4.9	6.4	8.7	
		Normal Duty (ND)	1.3	1.9	2.8	3.6	5.4	8.7	12.6	
	Frequency [Hz]	0~400Hz (IM sensorless: 0~120Hz)								
Voltage [V]	3-Phase 380~480V									
Input Rating	Voltage [V]	3-Phase 380~480VAC (-15%~+10%)								
	Frequency [Hz]	50~60Hz (±5%)								
	Rated Current [A]	Heavy Duty (HD)	1.1	2.4	4.2	5.9	9.8	12.9	17.5	
Normal Duty (ND)		2.0	3.3	5.5	7.5	10.8	17.5	25.4		
Weight [kg]			1.02 (1.04)	1.06 (1.08)	1.4 (1.44)	1.42 (1.46)	1.92 (1.98)	3.08 (3.24)	3.12 (3.28)	

- Maximum applicable capacity is indicated in case of using a 4-pole standard motor
- For the rated capacity, 200 and 400V class input capacities are based on 220 and 440V, respectively.
- The rated output current is limited based on the carrier frequency set at Cn.04.
- The output voltage becomes 20-40 % lower during no-load operations to protect the inverter from the impact of the motor closing and opening (0.4-4.0 kW models only).

## Control

Control Method	V/F, Slip Compensation, Sensorless Vector
Frequency Setting Resolution	Digital command: 0.01Hz Analog command: 0.06Hz(maximum frequency: 60 Hz)
Frequency Accuracy	1% of the maximum output frequency
V/F Pattern	Linear, squared, user V/F
Overload Capacity	HD: 150% 1 minute, ND: 120% 1minute
Torque Boost	Manual/Automatic torque boost

## Operation

Operation Mode	Select key pad, terminal strip, or communication operation	
Frequency Setting	Analog: -10~10[V], 0~10[V], 4~20[mA] Digital: Keypad	
Operation Function	PID control, 3-wire operation, Frequency limit, Second function, Anti-forward and reverse direction rotation, Commercial transition, Speed search, Power braking, Leakage reduction, Up-down operation, DC braking, Frequency jump, Slip compensation, Automatic restart, Automatic tuning, Energy buffering, Flux braking, Fire mode	
Input	Multi-Function Terminal (5 Points)	NPN (Sink) / PNP (Source) Selectable Function: Forward run, Reverse run, Reset, External trip, Emergency stop, Jog operation, Multi-step frequency-high, middle, low, Multi-step acceleration/ deceleration-high, middle, low, DC braking at stop, 2nd motor select, Frequency up/down, 3-wire operation, Change into normal operation during PID operation, Change into main body operation during option operation, Analog command frequency fixing, Acceleration/deceleration stop etc. Selectable
	Analog Input	V1: -10~10V, I2 4~20mA
Output	Multi-function Relay Terminal	Fault output and drive operation status output (N.O., N.C.) less than AC 250V 1A, less than DC 30V 1A
	Analog Output	0~12Vdc: Frequency, Output current, Output voltage, DC stage voltage etc. selectable

## Protective Function

Trip	Over current trip, external signal trip, ARM short current fault trip, over heat trip, input imaging trip, ground trip, motor over heat trip, I/O board link trip, no motor trip, parameter writing trip, emergency stop trip, command loss trip, external memory error, CPU watchdog trip, motor light load trip	Over voltage trip, temperature sensor trip, inverter over heat, option trip, output image trip, inverter overload trip, fan trip, pre-PID operation failure external brake trip, low voltage trip during operation, low voltage trip, analog input error, motor overload trip, over torque trip, under torque trip
Alarm	Command loss trip warning, overload warning, light load warning, inverter overload warning, fan operation warning, braking resistance braking rate warning, rotor time constant tuning error, inverter pre-overheat warning, over torque warning, under torque warning	
Momentary Power Loss	HD below 15ms (ND below 8ms): Continuous operation (To be within rated input voltage, rated output) HD above 15ms (ND above 8ms): Automatic restart operation enable	

## Environment

Cooling Type	Forced fan cooling structure
Protection Degree	IP20/UL Open (Default), UL Enclosed type 1 (Option)
Ambient Temperature	Ambient temperature under the condition of no ice or frost. HD: -10~50°C(14~122°F) / ND: -10~40°C(14~104°F) [However, recommended to use load below 80% when using at 50°C under light load]
Humidity	Relative humidity below 95% RH (no dew formation)
Storage Temperature	-20~65°C(-4~149°F)
Location	No corrosive gas, flammable gas, oil mist and dust etc. indoors (Pollution degree 2 environment)
Altitude, Vibration	Below 1,000m (From 1000 to 4000m, the rated input voltage and rated output current of the drive must be derated by 1% for every 100m.), below 9.8m/sec <sup>2</sup> (1G)
Pressure	70~106kPa

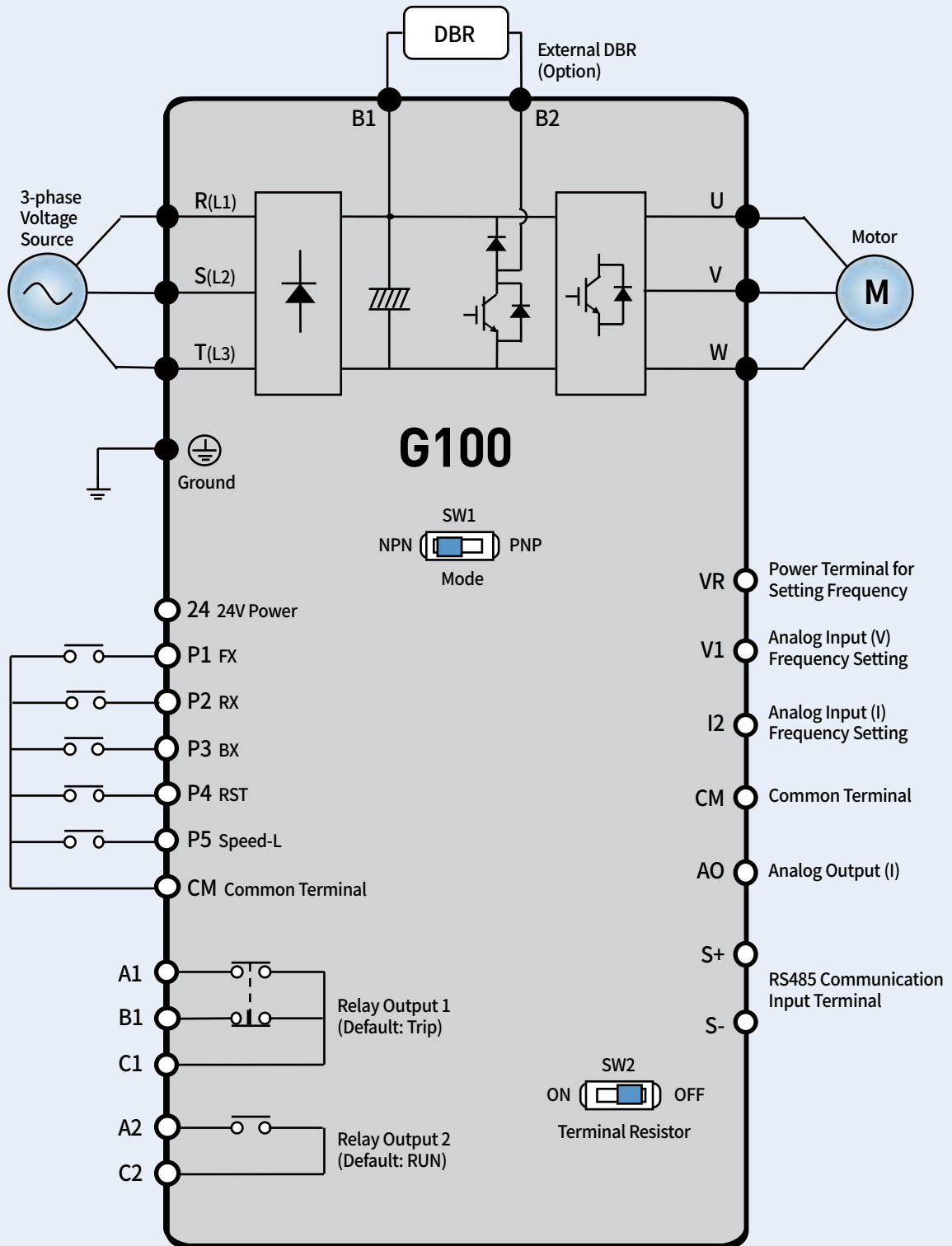

0.4/0.75kW

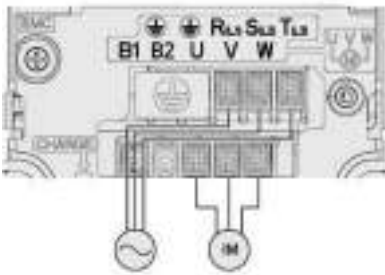

1.5/2.2kW

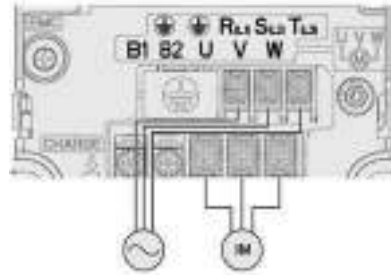

4kW

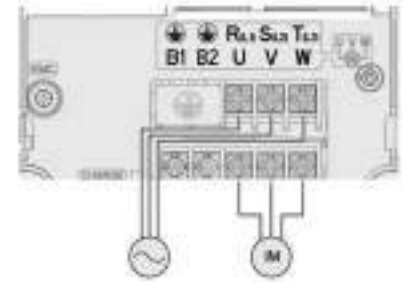

5.5/7.5kW

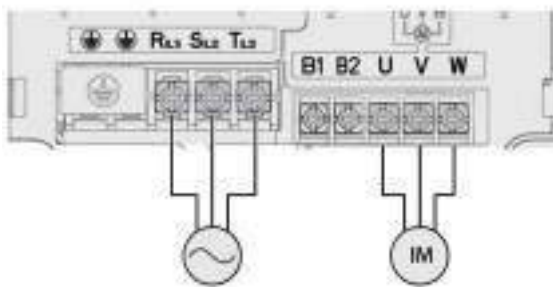

Terminal Labels	Name	Description
⊕	Ground terminal	Connect earth grounding.
R(L1)/S(L2)/T(L3)	AC power input terminal	Mains supply AC power connections.
B1/B2	Brake resistor terminals	Brake resistor wiring connection.
U/V/W	Motor output terminals	3-phase induction motor wiring connections.

Capacity (kW)		Terminal Screw Size	Rated Screw Torque (Kgf·cm/Nm)
3-Phase 200V Class	0.4	R/S/T, U/V/W : M3	R/S/T, U/V/W : 5.1/0.5
	0.75		
	1.5	R/S/T, U/V/W : M4	R/S/T, U/V/W : 12.1/1.2
	2.2		
	4	R/S/T, U/V/W : M4	R/S/T, U/V/W : 18.4/1.8
	5.5		
7.5	R/S/T : 24.0/2.4 U/V/W : 15.0/1.5		
3-Phase 400V Class	0.4	R/S/T, U/V/W : M3.5	R/S/T, U/V/W : 10.3/1.0
	0.75		
	1.5		
	2.2	R/S/T, U/V/W : M4	R/S/T, U/V/W : 18.4/1.8
	4		
	5.5	R/S/T, U/V/W : M4	R/S/T : 14.3/1.4 U/V/W : 18.4/1.8
7.5			

- Only use the specified torque on the screw heads otherwise damage could occur. Loose screws can cause overheating and damage.
- Use copper wires with 600V, 75°C specification.

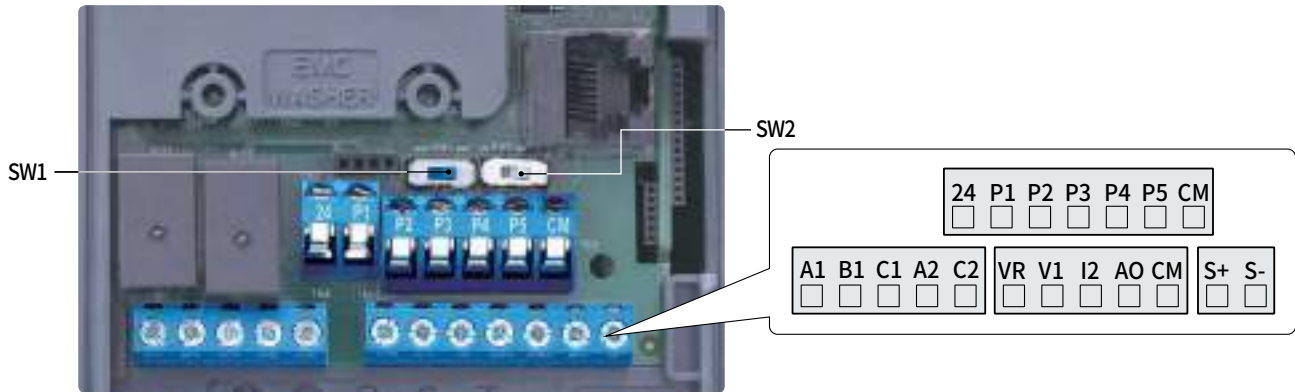

Terminals	Terminal Screw Size	Screw Torque (Kgf·cm/Nm)
P1~P5/CM/VR/V1/I2/AO/24/S+/S-	M2	2.2~2.5/0.22~0.25
A1/B1/C1, A2/C2	M2.6	4.0/0.4





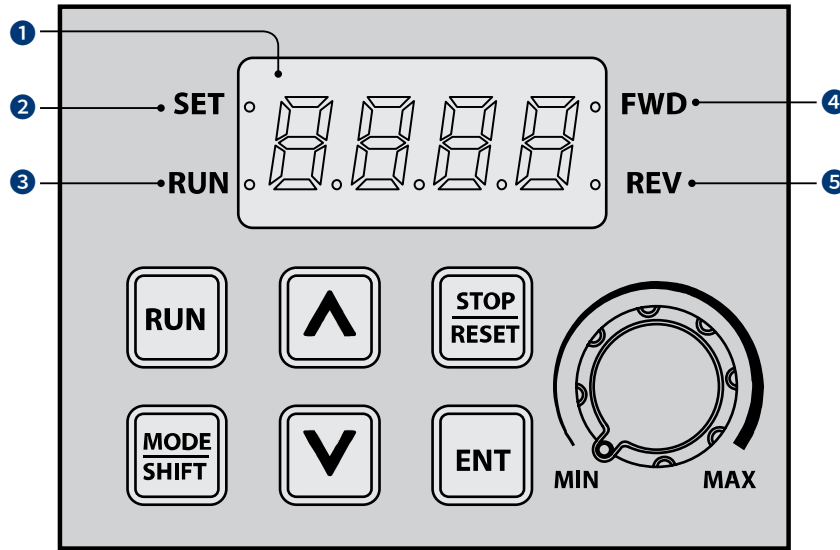

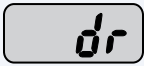

• Only use the specified torque on the screw heads otherwise damage could occur.  
Loose screws can cause overheating and damage.

Category	Terminal Labels	Name	Description
Multi-function Terminal Configuration	P1~P5	Multi-function Input 1-5	Configurable for multi-function input terminals. Factory default terminals and setup are as follows. <ul style="list-style-type: none"> <li>• P1: Fx</li> <li>• P2: Rx</li> <li>• P3: BX</li> <li>• P4: RST</li> <li>• P5: Speed-L</li> </ul>
	CM	Sequence common terminal	Common terminal for analog terminal inputs and outputs.
Analog Input	VR	Potentiometer frequency reference input	Used to setup or modify a frequency reference via analog voltage or current input. <ul style="list-style-type: none"> <li>• Maximum voltage output: 12 V</li> <li>• Maximum current output: 100mA</li> <li>• Potentiometer: 1/5 kΩ</li> </ul>
	V1	Voltage input for frequency reference input	Used to setup or modify a frequency reference via analog voltage input terminal. <ul style="list-style-type: none"> <li>• Unipolar: 0~10V (12V Max.)</li> <li>• Bipolar: -10~10V (±12V Max.)</li> </ul>
	I2	Current input for frequency reference input terminal	Used to setup or modify a frequency reference via current input terminal. <ul style="list-style-type: none"> <li>• Input current: 4-20 mA</li> <li>• Maximum Input current: 24mA</li> <li>• Input resistance: 249 Ω</li> </ul>
Analog Output	AO	Voltage output terminal	Used to send inverter output information to external devices: Output frequency, output current, output voltage, or a DC voltage. <ul style="list-style-type: none"> <li>• Output voltage: 0~10 V</li> <li>• Maximum output voltage/Current: 12 V, 10 mA</li> <li>• Factory default output: Frequency</li> </ul>
	24	External 24V power source	Maximum current output: 100mA
	A1/C1/B1	Fault signal output 1	Sends out alarm signals when the inverter's safety features are activated (AC 250V 1A, DC 30V 1A). <ul style="list-style-type: none"> <li>• Fault condition: A1 and C1 contacts are connected (B1 and C1 open connection)</li> <li>• Normal operation: B1 and C1 contacts are connected (A1 and C1 open connection)</li> </ul>
	A2/C2	Fault signal output 2	Sends out alarm signals when the inverter's safety features are activated (AC 250V 1A, DC 30V 1A). <ul style="list-style-type: none"> <li>• Fault condition: A2 and C2 contacts are open connection</li> <li>• Normal operation: A2 and C2 contacts are connected</li> </ul>
RS-485 Communication	S+/S-	RS-485 signal line	Used to send or receive RS-485 signals.

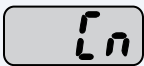
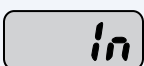

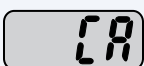
No.	Name	Function
1	7-Segment Display	Displays current operational status and parameter information.
2	SET Indicator	LED flashes during parameter configuration and when the ESC key operates as the multi-function key.
3	RUN Indicator	LED turns on (Steady) during an operation, and flashes during acceleration or deceleration.
4	FWD Indicator	LED turns on (Steady) during forward operation.
5	REV Indicator	LED turns on (Steady) during reverse operation.

Key	Name	Function
	[RUN] Key	Used to run the inverter (Inputs a RUN command).
	[STOP/RESET] Key	STOP: Stops the inverter. RESET: Resets the inverter if a fault or failure occurs.
	[▲] Key, [▼] Key	Switches between codes, or increases or decreases parameter values.
	[MODE/SHIFT] Key	Moves between groups or moves to the digit on the left when setting the parameter. Press the MODE/SHIFT key once again on the maximum number of digits to move to the minimum number of digits.
	[ENTER] Key	Switches from the selected state of parameter to the input state. Edits parameter and apply change. Accesses the operation information screen during failure on the failure screen.
	[ESC]	ESC to the initial display.
	[VOLUME]	Used to set the operation frequency.

Group	Keypad Display	Description
Operation	-	Configures basic parameters for inverter operation.
Drive		Configures parameters for basic operations. These include jog operation, motor capacity evaluation, torque boost, and other keypad related parameters.
Basic		Configures basic operation parameters. These parameters include motor parameters and multi-step frequency parameters.
Advanced		Configures acceleration or deceleration patterns, frequency limits, etc.
Control		Configures sensorless vector-related features.
Input Terminal		Configures input terminal-related features, including digital multi-functional inputs and analog inputs.
Output Terminal		Configures output terminal-related features such as relays and analog outputs.
Communication		Configures communication features for RS-485 or other communication options.
Application		Configures functions related to PID control.
Protection		Configures motor and inverter protection features
Motor 2 (Secondary Motor)		Configures secondary motor related features. The secondary motor (M2) group appears on the keypad only when one of the multi-function input terminals (In.65–In.69) has been set to 26 (Secondary motor).

## Group & Code selection

Step	Instruction	Keypad Display
1	Move to the group you want using the [MODE] keys. Press the [MODE] key for longer than 1 second to move in the opposite direction.	
2	Move up and down through the codes using the [▲] and [▼] keys until you locate the code that you require.	
3	Press the [ENT] key to save the change.	-

When moving up and down through the codes using the [▲] and [▼] keys in each group, there are cases where the code number does not increase or decrease. This is because the number was left blank in the inverter program by expecting additional features or the program was set up to not display the unused features.

## Navigating Directly to Different Codes





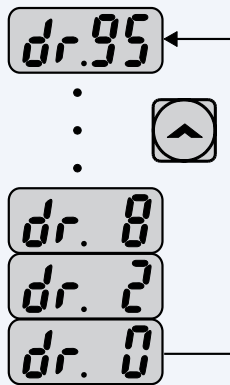









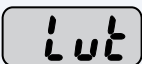
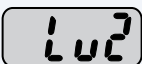

The following example details navigating to code dr. 95, from the initial code in the drive group (dr. 0). This example applies to all groups whenever you would like to navigate to a specific code number.

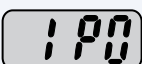
Step	Instruction	Keypad Display
1	Ensure that you are currently at the first code of the drive group (dr.0).	
2	Press the [ENT] key. Number "9" will flash.	
3	Press the [▼] key and change the ones' place of the code "95" to "5."	
4	Press the [MODE] to move to the tens' place. The cursor will move to the left and "05" will be displayed. At this time, the number "0" will be flashing.	
5	Press the [▲] key to change the tens' place number from "0" to "9," so the designated code is "95."	
6	Press the [ENT] key. Code dr.95 is displayed.	



## Fault Trips

### Protection functions for output current and input voltage

Keypad Display	Name	Type	Description
	Over Load	Latch	Displayed when the motor overload trip is activated and the actual load level exceeds the set level. Operates when Pr.20 is set to a value other than 0.
	Under Load	Latch	Displayed when the motor underload trip is activated and the actual load level is less than the set level. Operates when Pr.27 is set to a value other than 0.
	Over Current 1	Latch	Displayed when inverter output current exceeds 200% of the rated current.
	Over Voltage	Latch	Displayed when internal DC circuit voltage exceeds the specified value.
	Low Voltage	Level	Displayed when internal DC circuit voltage is less than the specified value.
	Low Voltage 2	Latch	Displayed when internal DC circuit voltage is less than the specified value during inverter operation. Operates when Pr.82 is set to 1.
	Ground Trip*	Latch	Displayed when a ground fault trip occurs on the output side of the inverter and causes the current to exceed the specified value. The specified value varies depending on inverter capacity.
	E-Thermal	Latch	Displayed based on inverse time-limit thermal characteristics to prevent motor overheating. Operates when Pr.40 is set to a value other than 0.
	Out Phase Open	Latch	Displayed when a 3-phase inverter output has one or more phases in an open circuit condition. Operates when bit 1 of Pr.05 is set to 1.
	In Phase Open	Latch	Displayed when a 3-phase inverter input has one or more phases in an open circuit condition. Operates only when bit 2 of Pr.05 is set to 1.
	Inverter OLT	Latch	Displayed when the inverter has been protected from overload and resultant overheating, based on inverse time-limit thermal characteristics. Allowable overload rates for the inverter are 150% for 1 min and 200% for 4 sec. Protection is based on inverter rated capacity, and may vary depending on the device's capacity.
	No Motor Trip	Latch	Displayed when the motor is not connected during inverter operation. Operates when Pr.31 is set to 1.
	Relay Open Trip	Latch	Occurs when the DC voltage relay is not operating when power the is input. The Pr-90 code must be set to 1 to operate.
	Over Torque Trip 1	Latch	Occurs when the output current is higher than the level set in Ou-68. Operates when OU-67 is set to 3, 4.
	Over Torque Trip 2	Latch	Occurs when the output current is higher than the level set in OU-71. Operates when OU-70 is set to 3, 4.
	Under Torque Trip 1	Latch	Occurs when the output current is lower than the level set in OU-68. Operates when OU-67 is set to 7, 8.
	Under Torque Trip 2	Latch	Occurs when the output current is lower than the level set in OU-71. Operates when OU-70 is set to 7, 8.

\* Ground Trip (GFT) feature is not provided in the products under 4.0 kW. Over current trip (OCT) or over voltage trip (OVT) may occur during low resistance grounding.

## Fault Trips







### Protection functions using abnormal internal circuit conditions and external signals

Keypad Display	Name	Type	Description
	Over Heat	Latch	Displayed when the temperature of the inverter heat sink exceeds the specified value.
	Over Current 2	Latch	Displayed when the DC circuit in the inverter detects a specified level of excessive, short circuit current.
	External Trip	Latch	Displayed when an external fault signal is provided by the multi-function terminal. Set one of the multi-function input terminals at In.65-69 to 4 (External trip) to enable external trip.
	BX	Level	Displayed when the inverter output is blocked by a signal provided from the multi-function terminal. Set one of the multi-function input terminals at In. 65-69 to 5 (BX) to enable input block function.
	H/W-Diag	Fatal	Displayed when an error is detected in the memory (EEPROM), analog-digital converter output (ADC Off Set), or CPU watchdog (Watch Dog-1, Watch Dog-2). <ul style="list-style-type: none"> <li>EEP Err: An error in reading/Writing parameters due to keypad or memory (EEPROM) fault.</li> <li>ADC Off Set: An error in the current sensing circuit (U/V/W terminal, current sensor, etc.).</li> </ul>
	NTC Open	Latch	Displayed when an error is detected in the temperature sensor of the insulated Gate Bipolar Transistor (IGBT).
	Fan Trip	Latch	Displayed when an error is detected in the cooling fan. Set Pr.79 to 0 to activate fan trip (for models below 22kW capacity).
	Pre-PID Fail	Latch	Displayed when pre-PID is operating with functions set at AP.34-AP.36. A fault trip occurs when a controlled variable (PID feedback) is measured below the set value and the low feedback continues, as it is treated as a load fault.
	Ext-Brake	Latch	Operates when the external brake signal is provided by the multi-function terminal. Occurs when the inverter output starting current remains below the set value at Ad.41. Set either OU.31 or OU.32 to 35 (BR Control).
	Overheat Pre Alarm	Latch	When the user has set Pr-78 to 2: Free-Run or 3: Dec, pre-overheating warning trip of inverter occurs if the inverter temperature exceeds the temperature set by the user in Pr-77.

### Protection functions for communication options

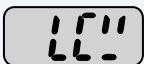
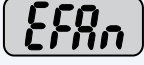
Keypad Display	Name	Type	Description
	Lost Command	Level	Displayed when a frequency or operation command error is detected during inverter operation by controllers other than the keypad (e.g., using a terminal block and a communication mode). Operates when Pr.12 is set to a value other than 0.
 	IO Board Trip	Latch	Displayed when the I/O board or external communication card is not connected to the inverter or there is a bad connection.
			Displayed when the <b>HOId</b> error code continues for more than 5 sec. (‘Errc’ -> ‘-rrc’ -> ‘-Er-c’ -> ‘-Er-c’ -> ‘-Err-’ -> ‘-rc’ -> ‘-Er-’ -> ‘-rc’ -> ‘-Errc’ -> ...)
	Option Trip -1	Latch	Displayed when a communication error is detected between the inverter and the communication board. Occurs when the communication option card is installed.

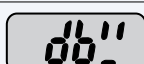
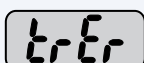
## Warning Messages

Keypad Display	Name	Description
	Over Load	Displayed when the motor is overloaded. Operates when Pr.17 is set to 1. To operate, select 5. Set the digital output terminal or relay (OU.31 or OU.33) to 5 (Over load) to receive overload warning output signals.
	Under Load	Displayed when the motor is underloaded. Operates when Pr.25 is set to 1. Set the digital output terminal or relay (OU.31 or OU.33) to 7 (Under load) to receive underload warning output signals.
	INV Over Load	Displayed when the overload time equivalent to 60 % of the inverter overheat protection (inverter IOLT) level, is accumulated. Set the digital output terminal or relay (OU.31 or OU.33) to 6 (IOL) to receive inverter overload warning output signals.
	Lost Command	Lost command warning alarm occurs even with Pr.12 set to 0. The warning alarm occurs based on the condition set at Pr.13- 15. Set the digital output terminal or relay (OU.31 or OU.33) to 13 (Lost command) to receive lost command warning output signals. If the communication settings and status are not suitable for P2P, a lost command alarm occurs.
	Fan Exchange	An alarm occurs when the value set at PRT-86 is less than the value set at PRT-87. To receive fan exchange output signals, set the digital output terminal or relay (OUT-31 or OUT-33) to 38 (Fan exchange).
	Fan Warning	Displayed when an error is detected from the cooling fan while Pr.79 is set to 1. Set the digital output terminal or relay (OU.31 or OU.33) to 8 (Fan warning) to receive fan warning output signals.
	DB Warn %ED	Displayed when the DB resistor usage rate exceeds the set value. Set the detection level at Pr.66.
	Retry Tr Tune	Operates when dr.9 is set to 4. The warning alarm occurs when the motor's rotor time constant (Tr) is either too low or too high.
	Overheat Pre Alarm	When the user has set Pr-78 to 1: Warning, pre-overheating warning of inverter occurs if the inverter temperature exceeds the temperature set by the user in Pr-77.

Code	Comm. Address	Name	Keypad Display	Setting Range		Initial Value	Property*	V/F	SL
-	0h1D00	Target frequency	0.00	0-Maximum frequency(Hz)		0.00	0	0	0
-	0h1D01	Acceleration time	ACC	0.0-600.0(s)		5.0	0	0	0
-	0h1D02	Deceleration time	dEC	0.0-600.0(s)		10.0	0	0	0
-	0h1D03	Command source	drv	0	Keypad	1: Fx / Rx-1	X	0	0
				1	Fx / Rx-1				
				2	Fx / Rx-2				
				3	Int 485				
				4	Fieldbus <sup>1)</sup>				
-	0h1D04	Frequency reference source	Frq	0	Keypad-1	0: Keypad-1	X	0	0
				1	Keypad-2				
				2	V1				
				4	V0 (Built-in volume)				
				5	I2				
				6	Int 485				
				8	Fiedbus <sup>1)</sup>				
-	0h1D05	Multi-step speed frequency 1	St1	0.00-Maximum frequency (Hz)		10.00	0	0	0
-	0h1D06	Multi-step speed frequency 2	St2	0.00-Maximum frequency (Hz)		20.00	0	0	0
-	0h1D07	Multi-step speed frequency 3	St3	0.00-Maximum frequency (Hz)		30.00	0	0	0
-	0h1D08	Output current	CUr			-	-	0	0
-	0h1D09	Motor revolutions per minute	Rpm				-	0	0
-	0h1D0A	Inverter DC voltage	dCL	-		-	-	0	0
-	0h1D0B	Inverter output voltage	vOL				-	0	0
-	0h1D0C	Out of order signal	nOn				-	0	0
-	0h1D0D	Select rotation direction	drC	F	Forward direction operation	F	0	0	0
				r	Reverse run				

\* SL: Sensorless vector control (dr.09), Property: Write-enabled during operation

<sup>1)</sup> Table of options are provided separately in the option manual.

Code	Comm. Address	Name	Setting Range	Initial Value	Property*	V/F	SL	
dr-00	-	Jump code	1-99	9	O	O	O	
dr-09	0h1109	Control mode	0	V / F	0: V / F	X	O	O
			2	Slip compen				
			4	IM sensorless				
dr-11	0h110B	Jog frequency	0.00, Start frequency-Maximum frequency(Hz)	10.00	O	O	O	
dr-12	0h110C	Jog run acceleration time	0.0-600.0(s)	20.0	O	O	O	
dr-13	0h110D	Jog run deceleration time	0.0-600.0(s)	30.0	O	O	O	
dr-14	0h110E	Motor capacity	0: 0.2kW 1: 0.4kW 2: 0.75kW 3: 1.1kW 4: 1.5kW 5: 2.2kW 6: 3.0kW 7: 3.7kW 8: 4.0kW 9: 5.5kW 10: 7.5kW 11:11.0kW	Varies by motor capacity	X	O	O	
dr-15	0h110F	Torque boost mode	0	Manual	0: Manual	X	O	X
			1	Auto				
dr-16	0h1110	Forward torque boost	0.0-15.0(%)	2.0	X	O	X	
dr-17	0h1111	Reverse torque boost	0.0-15.0(%)	2.0	X	O	X	
dr-18	0h1112	Base frequency	30.00-400.00(Hz) [V / F, Slip compen] 40.00-120.00(Hz) [IM sensorless]	60.00	X	O	O	
dr-19	0h1113	Start frequency	0.01-10.00(Hz)	0.50	X	O	O	
dr-20	0h1114	Maximum frequency	40.00-400.00(Hz) [V / F, Slip compen] 40.00-120.00(Hz) [IM sensorless]	60.00	X	O	O	
dr-26 <sup>2)</sup>	0h111A	Auto torque boost filter gain	1~1000	2	O	O	X	
dr-27 <sup>2)</sup>	0h111B	Auto torque boost motoring gain	0.0-300.0[%]	50.0	O	O	X	
dr-28 <sup>2)</sup>	0h111C	Auto torque boost regeneration gain	0.0-300.0[%]	50.0	O	O	X	
dr-80	0h1150	Select ranges at power input	Select ranges inverter displays at power input		0: Operation frequency	O	O	O
			0	Operation frequency				
			1	Acceleration time				
			2	Deceleration time				
			3	Command source				
			4	Frequency reference source				
			5	Multi-step speed frequency 1				
			6	Multi-step speed frequency 2				
			7	Multi-step speed frequency 3				
			8	Output current				
			9	Motor RPM				
			10	Inverter DC voltage				
			11	User select signal (dr.81)				
			12	Currently out of order				
13	Select run direction							

\* SL: Sensorless vector control (dr.09), Property: Write-enabled during operation

<sup>2)</sup> Appears when Dr15 is 1 (automatic torque boost).

Code	Comm. Address	Name	Setting Range	Initial Value	Property*	V/F	SL
dr-80	0h1150	Select ranges at power input	14	Output current 2	0: Operation frequency	-	-
			15	Motor RPM 2			
			16	Inverter DC voltage 2			
			17	User select signal 2(dr.81)			
dr-81	0h1151	Select monitor code	Monitors user selected code		0: Output voltage	0	0
			0	Output voltage(V)			
			1	Output power(kW)			
			2	Torque(kgf·m)			
dr-89	0h03E3	Display changed parameter display	0	View all	0: View All	0	0
			1	View changed			
dr-91	0h115B	Smart copy	0	None	0: None	X	0
			1	Smartdownload			
			3	Smartupload			
			4	Remoteupload			
			5	Remotedownload			
dr-92	0h115C	Parameter save	0	None	0: None	X	0
			1	Parameter save			
dr-93	0h115D	Parameter initialization	0	No	0: No	X	0
			1	All grp			
			2	dr grp			
			3	bA grp			
			4	Ad grp			
			5	Cn grp			
			6	In grp			
			7	OU grp			
			8	CM grp			
			9	AP grp			
			11	AO grp			
			12	Pr grp			
			13	M2 grp			
			14	run grp			
dr-94	0h115E	Password registration	0~9999			0	0
dr-95	0h115F	Parameter lock settings	0~9999			0	0
dr-97	0h1161	Software version				-	0
dr-98	0h1162	Display I / O board version				-	0

\* SL: Sensorless vector control (dr.09), Property: Write-enabled during operation

# Basic Function Group (PAR → bA)

General Drive

Code	Comm. Address	Name	Setting Range	Initial Value	Property*	V/F	SL	
bA-00	-	Jump code	1~99	20	O	O	O	
bA-01	0h1201	Auxiliary reference source	0	None	0: None	X	O	O
			1	V1				
			3	V0				
			4	I2				
bA-02 <sup>3)</sup>	0h1202	Auxiliary command calculation type	0	M+(G*A)	0: M+(GA)	X	O	O
			1	Mx (G*A)				
			2	M / (G*A)				
			3	M+[M*(G*A)]				
			4	M+G*2(A-50%)				
			5	Mx[G*2(A-50%)				
			6	M / [G*2(A-50%)]				
			7	M+M*G*2(A-50%)				
bA-03 <sup>3)</sup>	0h1203	Auxiliary frequency reference gain	-200.0~200.0(%)	100.0	O	O	O	
bA-04	0h1204	2nd command source	0	Keypad	1: Fx / Rx-1	X	O	O
			1	Fx / Rx-1				
			2	Fx / Rx-2				
			3	Int 485				
			4	FieldBus <sup>4)</sup>				
bA-05	0h1205	2nd frequency source	0	Keypad-1	0: Keypad-1	O	O	O
			1	Keypad-2				
			2	V1				
			4	V0				
			5	I2				
			6	Int 485				
			8	FieldBus <sup>4)</sup>				
bA-07	0h1207	V / F pattern	0	Linear	0: Linear	X	O	X
			1	Square				
			2	User V / F				
			3	Square 2				
bA-08	0h1208	Acc / Dec reference	0	Max freq	0: Max freq	X	O	O
			1	Delta freq				
bA-09	0h1209	Time scale setting	0	0.01 sec	1: 0.1 sec	X	O	O
			1	0.1 sec				
			2	1 sec				
bA-10	0h120A	input power frequency	0	60Hz	0: 60Hz	X	O	O
			1	50Hz				
bA-11	0h120B	Number of motor poles	2~48	Dependent on motor setting	X	O	O	
bA-12	0h120C	Rated slip speed	0~3000(Rpm)		X	O	O	
bA-13	0h120D	Motor rated current	1.0~1000.0(A)		X	O	O	
bA-14	0h120E	Motor no-load current	0.0~1000.0(A)		X	O	O	
bA-15	0h120F	Motor rated voltage	0, 100~480(V)		0	X	O	O

•  In the following table, data shaded in blue will be displayed when the related code has been selected.

• SL: Sensorless vector control (dr.09), Property: Write-enabled during operation

<sup>3)</sup> Displayed if bA.01 is not set to 0 (None).

<sup>4)</sup> Table of options are provided separately in the option manual.

Code	Comm. Address	Name	Setting Range	Initial Value	Property*	V/F	SL	
bA-16	0h1210	Motor efficiency	64~100(%)	Dependent on motor setting	X	O	O	
bA-17	0h1211	Load inertia rate	0~8	0	X	O	O	
bA-18	0h1212	Trim power display	70~130(%)	100%	O	O	O	
bA-19	0h1213	Input power voltage	170~480V	220 / 380V	O	O	O	
bA-20	-	Auto tuning	0	None	0: None	X	X	O
			1	All(Rotation type)				
			2	All(Static type)				
			3	Rs+Lsigma(Rotation type)				
			6	Tr(Static type)				
bA-21	-	Stator resistance	Dependent on motor setting	Dependent on motor setting	X	X	O	
bA-22	-	Leakage inductance			X	X	O	
bA-23	-	Stator inductance			X	X	O	
bA-24 <sup>5)</sup>	-	Rotor time constant	25~5000(ms)	-	X	X	O	
bA-41 <sup>6)</sup>	0h1229	User frequency 1	0.00-Maximum frequency(Hz)	15.00	X	O	X	
bA-42 <sup>6)</sup>	0h122A	User voltage 1	0~100(%)	25	X	O	X	
bA-43 <sup>6)</sup>	0h122B	User frequency 2	0.00-Maximum frequency(Hz)	30.00	X	O	X	
bA-44 <sup>6)</sup>	0h122C	User voltage 2	0~100(%)	50	X	O	X	
bA-45 <sup>6)</sup>	0h122D	User frequency 3	0.00-Maximum frequency(Hz)	45.00	X	O	X	
bA-46 <sup>6)</sup>	0h122E	User voltage 3	0~100(%)	75	X	O	X	
bA-47 <sup>6)</sup>	0h122F	User frequency 4	0.00-Maximum frequency(Hz)	Maximum frequency	X	O	X	
bA-48 <sup>6)</sup>	0h1230	User voltage 4	0~100(%)	100	X	O	X	
bA-53 <sup>7)</sup>	0h1235	Multi-step speed frequency 4	0.00-Maximum frequency(Hz)	40.00	O	O	O	
bA-54 <sup>7)</sup>	0h1236	Multi-step speed frequency 5	0.00-Maximum frequency(Hz)	50.00	O	O	O	
bA-55 <sup>7)</sup>	0h1237	Multi-step speed frequency 6	0.00-Maximum frequency(Hz)	Maximum frequency	O	O	O	
bA-56 <sup>7)</sup>	0h1238	Multi-step speed frequency 7	0.00-Maximum frequency(Hz)	Maximum frequency	O	O	O	
bA-70	0h1246	Multi-step acceleration time 1	0.0~600.0(s)	20.0	O	O	O	
bA-71	0h1247	Multi-step deceleration time 1	0.0~600.0(s)	20.0	O	O	O	
bA-72 <sup>8)</sup>	0h1248	Multi-step acceleration time 2	0.0~600.0(s)	30.0	O	O	O	
bA-73 <sup>8)</sup>	0h1249	Multi-step deceleration time 2	0.0~600.0(s)	30.0	O	O	O	
bA-74 <sup>8)</sup>	0h124A	Multi-step acceleration time 3	0.0~600.0(s)	40.0	O	O	O	
bA-75 <sup>8)</sup>	0h124B	Multi-step deceleration time 3	0.0~600.0(s)	40.0	O	O	O	
bA-76 <sup>8)</sup>	0h124C	Multi-step acceleration time 4	0.0~600.0(s)	50.0	O	O	O	
bA-77 <sup>8)</sup>	0h124D	Multi-step deceleration time 4	0.0~600.0(s)	50.0	O	O	O	
bA-78 <sup>8)</sup>	0h124E	Multi-step acceleration time 5	0.0~600.0(s)	40.0	O	O	O	
bA-79 <sup>8)</sup>	0h124F	Multi-step deceleration time 5	0.0~600.0(s)	40.0	O	O	O	
bA-80 <sup>8)</sup>	0h1250	Multi-step acceleration time 6	0.0~600.0(s)	30.0	O	O	O	
bA-81 <sup>8)</sup>	0h1251	Multi-step deceleration time 6	0.0~600.0(s)	30.0	O	O	O	
bA-82 <sup>8)</sup>	0h1252	Multi-step acceleration time 7	0.0~600.0(s)	20.0	O	O	O	
bA-83 <sup>8)</sup>	0h1253	Multi-step deceleration time 7	0.0~600.0(s)	20.0	O	O	O	

\* In the following table, data shaded in blue will be displayed when the related code has been selected.

• SL: Sensorless vector control (dr.09), Property: Write-enabled during operation

<sup>5)</sup> Displayed when dr.09 is set to 4(IM sensorless).

<sup>6)</sup> Displayed if either bA.07 or M2.25 is set to 2 (User V / F).

<sup>7)</sup> Displayed if one of In.65-71 is set to speed-L / M / H.

<sup>8)</sup> Displayed one of In.65-71 is set to Xcel-L / M / H.

# Expanded Function Group (PAR → Ad)

General Drive

Code	Comm. Address	Name	Setting Range	Initial Value	Property*	V/F	SL
Ad-00	-	Jump code	1~99	24	O	O	O
Ad-01	0h1301	Acceleration pattern	0 Linear	0: Linear	X	O	O
Ad-02	0h1302	Deceleration pattern	1 S-curve		X	O	O
Ad-03 <sup>9)</sup>	0h1303	S-curve acceleration start point gradient	1~100(%)	40	X	O	O
Ad-04 <sup>9)</sup>	0h 1304	S-curve acceleration end point gradient	1~100(%)	40	X	O	O
Ad-05 <sup>10)</sup>	0h1305	S-curve deceleration start point gradient	1~100(%)	40	X	O	O
Ad-06 <sup>10)</sup>	0h1306	S-curve deceleration end point gradient	1~100(%)	40	X	O	O
Ad-07	0h1307	Start mode	0 Acc	0: Acc	X	O	O
			1 Dc-start				
Ad-08	0h1308	Stop mode	0 Dec	0: Dec	X	O	O
			1 Dc-brake				
			2 Free-run				
			4 Power braking				
Ad-09	0h1309	Run prevention options	0 None	0: None	X	O	O
			1 Forward prev				
			2 Reverse prev				
Ad-10	0h130A	Starting with power on	0 No	0: No	O	O	O
			1 Yes				
Ad-12 <sup>11)</sup>	0h130C	Start DC braking time	0.00~60.00(s)	0.00	X	O	X
Ad-13	0h130D	Amount of applied DC	0-inverter rated current(%)	50	X	O	X
Ad-14 <sup>12)</sup>	0h130E	Output blocking time before DC braking	0.00~60.00(s)	0.10	X	O	O
Ad-15 <sup>12)</sup>	0h130F	DC braking time	0.00~60.00(s)	1.00	X	O	O
Ad-16 <sup>12)</sup>	0h1310	DC braking rate	0 - inverter rated current / motor rated current x 100 (%)	50	X	O	O
Ad-17 <sup>12)</sup>	0h1311	DC braking frequency	Start frequency-60Hz	5.00	X	O	O
Ad-20	0h1314	Dwell frequency on acceleration	Start frequency-maximum frequency(Hz)	5.00	X	O	O
Ad-21	0h1315	Dwell operation time on acceleration	0.0~60.0(s)	0.0	X	O	O
Ad-22	0h1316	Dwell frequency during deceleration	Start frequency-maximum frequency(Hz)	5.00	X	O	O
Ad-23	0h1317	Operation time during deceleration	0.0~60.0(s)	0.0	X	O	O
Ad-24	0h1318	Frequency limit	0 No	0: No	X	O	O
			1 Yes				
Ad-25 <sup>13)</sup>	0h1319	Frequency lower limit value	0.00-Upper limit frequency(Hz)	0.50	O	O	O
Ad-26 <sup>13)</sup>	0h131A	Frequency upper limit value	Lower limit frequency-maximum frequency(Hz)	Maximum frequency	X	O	O
Ad-27	0h131B	Frequency jump	0 No	0: No	X	O	O
			1 Yes				
Ad-28 <sup>14)</sup>	0h131C	Jump frequency lower limit 1	0.00-Jump frequency upper limit1(Hz)	10.00	O	O	O
Ad-29 <sup>14)</sup>	0h131D	Jump frequency upper limit 1	Jump frequency lower limit1-maximum frequency(Hz)	15.00	O	O	O
Ad-30 <sup>14)</sup>	0h131E	Jump frequency lower limit 2	00-Jump frequency upper limit2(Hz)	20.00	O	O	O
Ad-31 <sup>14)</sup>	0h131F	Jump frequency upper limit 2	Jump frequency lower limit2-maximum frequency(Hz)	25.00	O	O	O

\*  In the following table, data shaded in blue will be displayed when the related code has been selected.

• SL: Sensorless vector control (dr.09), Property: Write-enabled during operation

<sup>9)</sup> Displayed when Ad. 01 is set to 1 (S-curve).

<sup>10)</sup> Displayed when the Ad. 02 code is set to 1 (S-curve).

<sup>11)</sup> Displayed when Ad. 07 is set to 1 (DC-start).

<sup>12)</sup> Displayed when Ad. 08 is set to 1 (DC-brake).

<sup>13)</sup> Displayed when the Ad.24 code is set to 1 (Yes).

<sup>14)</sup> Displayed when the Ad.27 code is set to 1 (Yes).

Code	Comm. Address	Name	Setting Range	Initial Value	Property*	V/F	SL	
Ad-32 <sup>14)</sup>	0h1320	Jump frequency lower limit 3	0.00-Jump frequency upper limit3(Hz)	30.00	O	O	O	
Ad-33 <sup>14)</sup>	0h1321	Jump frequency upper limit 3	Jump frequency lower limit3-maximum frequency(Hz)	35.00	O	O	O	
Ad-41 <sup>15)</sup>	0h1329	Brake release current	0.0-180.0(%)	50.0	O	O	O	
Ad-42 <sup>15)</sup>	0h132A	Brake release delay time	0.00-10.00(s)	1.00	X	O	O	
Ad-44 <sup>15)</sup>	0h132C	Brake release forward frequency	0.00-Maximum frequency(Hz)	1.00	X	O	O	
Ad-45 <sup>15)</sup>	0h132D	Brake release reverse frequency	0.00-Maximum frequency(Hz)	1.00	X	O	O	
Ad-46 <sup>15)</sup>	0h132E	Brake engage delay time	0.00-10.00(s)	1.00	X	O	O	
Ad-47 <sup>15)</sup>	0h132F	Brake engage frequency	0.00-Maximum frequency(Hz)	2.00	X	O	O	
Ad-50	0h1332	Energy saving operation	0	None	0: None	X	O	X
			1	Manual				
			2	Auto				
Ad-51 <sup>16)</sup>	0h1333	Energy saving amount	0-30(%)	0	O	O	X	
Ad-60	0h133C	Acc / Dec time transition frequency	0.00-Maximum frequency(Hz)	0.00	X	O	O	
Ad-61	0h133D	Rotation count speed gain	0.1-6000.0[%]	100.0	O	O	O	
Ad-62	0h133E	Rotation count speed scale	0	x 1	0: x 1	O	O	O
			1	x 0.1				
			2	x 0.01				
			3	x 0.001				
			4	x 0.0001				
Ad-63	0h133F	Rotation count speed unit	0	Rpm	0: rpm	O	O	O
			1	mpm				
Ad-64	0h1340	Cooling fan control	0	During run	0: During run	O	O	O
			1	Always on				
			2	Temp control				
Ad-65	0h1341	Up / Down operation frequency save	0	No	0: No	O	O	O
			1	Yes				
Ad-66	0h1342	Output contact on / Off control options	0	None	0: None	X	O	O
			1	V1				
			3	V0				
			4	I2				
Ad-67	0h1343	Output contact on level	Output contact off level-100.00 %	90.00	X	O	O	
Ad-68	0h1344	Output contact off level	-100.00-output contact on level (%)	10.00	X	O	O	
Ad-70	0h1346	Safe operation selection	0	Always enable	0: Always enable	X	O	O
			1	DI Dependent				
Ad-71 <sup>17)</sup>	0h1347	Safe operation stop options	0	Free-run	0: Free-run	X	O	O
			1	Q-Stop				
			2	Q-Stop resume				
Ad-72 <sup>17)</sup>	0h1348	Safe operation deceleration time	0.0~600.0(s)	5.0	O	O	O	

\*  In the following table, data shaded in blue will be displayed when the related code has been selected.

\* SL: Sensorless vector control (dr.09), Property: Write-enabled during operation

<sup>14)</sup> Displayed when the Ad.27 code is set to 1 (Yes).

<sup>15)</sup> Displayed if either OU.31 or OU.33 is set to 35 (BR Control).

<sup>16)</sup> Displayed if Ad.50 is not set to 0 (None).

<sup>17)</sup> Displayed when Ad.70 is set to 1 (DI Dependent).

Code	Comm. Address	Name	Setting Range	Initial Value	Property*	V/F	SL
Ad-74	0h134A	Selection of regeneration evasion function for press	0	No	0: No	X	O
			1	Yes			
Ad-75	0h134B	Voltage level of regeneration evasion motion for press	200V : 300-400V		350	X	O
			400V : 600-800V		700		
Ad-76 <sup>18)</sup>	0h134C	Compensation frequency limit of regeneration evasion for press	0.00-10.00 Hz		1.00	X	O
Ad-77 <sup>18)</sup>	0h134D	Regeneration evasion for press P gain	0.0-100.0%		50.0	O	O
Ad-78 <sup>18)</sup>	0h134E	Regeneration evasion for press I gain	20-30000(ms)		500	O	O
Ad-79	0h134F	DB Unit turn on voltage level	200V: Min <sup>19)</sup> 400[V]		390[V]	X	O
			400V: Min <sup>19)</sup> 800[V]		780[V]		
Ad-80	0h1350	Fire Mode selection	0	None	0: None	X	O
			1	Fire mode			
			2	Fire mode test			
Ad-81 <sup>20)</sup>	0h1351	Fire mode operation frequency	Start frequency-maximum frequency [Hz]		60.00	X	O
Ad-82 <sup>20)</sup>	0h1352	Fire mode run direction	0	Forward	0: Forward	X	O
			1	Reverse			
Ad-83 <sup>20)</sup>		Fire mode operation count	Not configurable		-	-	-

•  In the following table, data shaded in blue will be displayed when the related code has been selected.

• SL: Sensorless vector control (dr.09), Property: Write-enabled during operation

<sup>18)</sup> Displayed when the Ad.74 code is set to 1 (Yes).

<sup>19)</sup> Voltage type which DC converted the bA.19 AC input voltage: +20V (200Vtype), +40V (400V type). 200V type is limited to 350V and 400V type is limited to 600V.

<sup>20)</sup> Displayed if Ad.80 is not set to 0 (None).

Code	Comm. Address	Name	Setting Range	Initial Value	Property*	V/F	SL	
Cn-00	-	Jump code	1~99	4	O	O	O	
Cn-04 <sup>21)</sup>	0h1404	Carrier frequency	Heavy duty	V / F: 1.0~15.0(kHz) IM: 2.0~15.0(kHz)	3.0	X	O	O
			Normal duty	V / F: 1.0~ 5.0(kHz) IM: 2.0~5.0(kHz)	2.0			
Cn-05	0h1405	Switching mode	0   Normal PWM	0: Normal PWM	X	O	O	
Cn-09	0h1409	Initial excitation time	0.00~60.00(s)	1.00	X	X	O	
Cn-10	0h140A	Initial excitation amount	100.0~300.0(%)	100.0	X	X	O	
Cn-11	0h140B	Continued operation duration	0.00~60.00(s)	0.00	X	X	O	
Cn-21	0h1415	Low - speed torque compensation gain	50~300(%)	Varies by motor capacity	X	X	O	
Cn-22	0h1416	Output torque compensation gain	50~300(%)	Varies by motor capacity	X	X	O	
Cn-23	0h1417	Speed deviation sub compensation gain	50~300(%)	Varies by motor capacity	X	X	O	
Cn-24	0h1418	Speed deviation main compensation gain	50~300(%)	Varies by motor capacity	X	X	O	
Cn-29	0h141D	No-load speed deviation compensation gain	0.50~2.00	1.06	O	X	O	
Cn-30	0h141E	Speed controller adjustment gain	2.0~10.0	4.0	O	X	O	
Cn-53	0h1435	Torque limit setting	0	Keypad-1	0: Keypad-1	X	X	O
			1	Keypad-2				
			2	V1				
			4	V0				
			5	I2				
			6	Int 485				
			8	FieldBus				
Cn-54 <sup>22)</sup>	0h1436	Positive-direction reverse torque limit	0.0~200.0(%)	180	O	X	O	
Cn-55 <sup>22)</sup>	0h1437	Positive-direction regeneration torque limit	0.0~200.0(%)	180	O	X	O	
Cn-56 <sup>22)</sup>	0h1438	Negative-direction regeneration torque limit	0.0~200.0(%)	180	O	X	O	
Cn-57 <sup>22)</sup>	0h1439	Negative-direction reverse torque limit	0.0~200.0(%)	180	O	X	O	
Cn-70	0h 1446	Speed search mode selection	0	Flying start-1 <sup>23)</sup>	0: Flying start-1	X	O	O
			1	Flying start-2				
Cn-71	0h1447	Speed search operation selection	bit	0000~1111	0000 <sup>24)</sup>	X	O	O
			0001	Selects the speed search function at acceleration.				
			0010	Initialization after a fault trip				
			0100	Restart after instantaneous power interruption				
			1000	Starting with power-on				

\* In the following table, data shaded in blue will be displayed when the related code has been selected.

\* SL: Sensorless vector control (dr.09), Property: Write-enabled during operation

<sup>21)</sup> It is for 5.5~7.5kW.

<sup>22)</sup> Displayed when dr.09 is set to 4 (IM Sensorless). This will change the initial value of the parameter at Ad.74 (Torque limit) to 150%.

<sup>23)</sup> Will not be displayed if dr.09 is set to 4 (IM Sensorless).

<sup>24)</sup> The initial value 0000 will be displayed on the keypad as .

Code	Comm. Address	Name	Setting Range	Initial Value	Property*	V/F	SL
Cn-72 <sup>25)</sup>	0h1448	Speed search reference current	80~200(%)	150	O	O	O
Cn-73 <sup>26)</sup>	0h1449	Speed search proportional gain	0~9999	Flying start-1: 100	O	O	O
				Flying start-2: 600 <sup>27)</sup>			
Cn-74 <sup>26)</sup>	0h144A	Speed search integral gain	0~9999	Flying start-1: 200	O	O	O
				Flying start-2: 1000			
Cn-75 <sup>26)</sup>	0h144B	Output block time before speed search	0.0~60.0(s)	1.0	X	O	O
Cn-76 <sup>26)</sup>	0h144C	Speed search estimator gain	50~150(%)	100	O	O	O
Cn-77	0h144D	Energy buffering selection	0	No	0: No	X	O
			1	KEB-1			
			2	KEB-2			
Cn-78 <sup>28)</sup>	0h144E	Energy buffering start level	110.0~200.0(%)	125.0	X	O	O
Cn-79 <sup>28)</sup>	0h144F	Energy buffering stop level	Cn78~210.0(%)	130.0	X	O	O
Cn-80 <sup>28)</sup>	0h1450	Energy buffering P gain	0~20000	1000	O	O	O
Cn-81 <sup>28)</sup>	0h1451	Energy buffering I gain	1~20000	500	O	O	O
Cn-82 <sup>28)</sup>	0h1452	Energy buffering slip gain	0~2000.0%	30.0	O	O	O
Cn-83 <sup>28)</sup>	0h1453	Energy buffering acceleration time	0.0~600.0(s)	10.0	O	O	O

•  In the following table, data shaded in blue will be displayed when the related code has been selected.

• SL: Sensorless vector control (dr.09), Property: Write-enabled during operation

<sup>25)</sup> Displayed when any of the Cn.71 code bits are set to 1 and Cn70 is set to 0 (Flying start-1).

<sup>26)</sup> Displayed when any of the Cn.71 code bits are set to 1.

<sup>27)</sup> The initial value is 1200 when the motor-rated capacity is less than 7.5 kW

<sup>28)</sup> Displayed when Cn.77 is not set to 0 (No).

Code	Comm. Address	Name	Setting Range	Initial Value	Property*	V/F	SL
In-00	-	Jump code	1~99	65	O	O	O
In-01	0h1501	Frequency for maximum analog input	Start frequency-maximum frequency(Hz)	Maximum frequency	O	O	O
In-02	0h1502	Torque at maximum analog input	0.0~200.0(%)	100.0	O	X	X
In-05	0h1505	V1 input voltage display	-12.00~12.00(V)	0.00	-	O	O
In-06	0h1506	V1 input polarity selection	0	Unipolar	0: Unipolar	X	O
			1	Bipolar			
In-07	0h1507	Time constant of V1 input filter	0~10000(ms)	100	O	O	O
In-08	0h1508	V1 Minimum input voltage	0.00~10.00(V)	0.00	O	O	O
In-09	0h1509	V1 output at Minimum voltage(%)	0.00~100.00(%)	0.00	O	O	O
In-10	0h150A	V1 Maximum input voltage	0.00~12.00(V)	10.00	O	O	O
In-11	0h150B	V1 output at Maximum voltage(%)	0.00~100.00(%)	100.00	O	O	O
In-12 <sup>29)</sup>	0h150C	V1 Minimum input voltage	-10.00~ 0.00(V)	0.00	O	O	O
In-13 <sup>29)</sup>	0h150D	V1 output at Minimum voltage(%)	-100.00~0.00(%)	0.00	O	O	O
In-14 <sup>29)</sup>	0h150E	V1 Maximum input voltage	-12.00~ 0.00(V)	-10.00	O	O	O
In-15 <sup>29)</sup>	0h150F	V1 output at Maximum voltage(%)	-100.00~0.00(%)	-100.00	O	O	O
In-16	0h1510	Changing rotation direction of V1	0	No	0: No	O	O
			1	Yes			
In-17	0h1511	V1 quantization level	0.00 <sup>30)</sup> , 0.04~10.00(%)	0.04	X	O	O
In-35	0h1523	V0 input voltage display	0.00~5.00(V)	0.00	-	O	O
In-37	0h1525	Time constant of V0 input filter	0~10000(ms)	100	O	O	O
In-38	0h1526	V0 Minimum input voltage	0.00~5.00(V)	0.00	O	X	O
In-39	0h1527	V0 output at minimum voltage(%)	0.00~100.00(%)	0.00	O	O	O
In-40	0h1528	V0 Maximum input voltage	0.00~5.00(V)	5.00	O	X	O
In-41	0h1529	V0 output at maximum voltage(%)	0.00~100.00(%)	100.00	O	O	O
In-46	0h152E	Changing rotation direction of V0	0	No	0: No	O	O
			1	Yes			
In-47	0h152F	V0 quantization level	0.00 <sup>30)</sup> , 0.04~ 10.00(%)	0.04	O	O	O
In-50	0h1532	I2 input voltage display	0~24(mA)	0.00	-	O	O
In-52	0h1534	I2 input filter time constant	0~10000(ms)	100	O	O	O
In-53	0h1535	I2 minimum input current	0.00~20.00(mA)	4.00	O	O	O
In-54	0h1536	I2 output at minimum current(%)	0.00~100.00(%)	0.00	O	O	O
In-55	0h1537	I2 maximum input current	0.00~24.00(mA)	20.00	O	O	O
In-56	0h1538	I2 output at maximum current(%)	0.00~100.00(%)	100.00	O	O	O
In-61	0h153D	Changing rotation direction of I2	0	No	0: No	O	O
			1	Yes			
In-62	0h153E	I2 quantization level	0.00 <sup>29)</sup> , 0.04~10.00(%)	0.04	O	O	O
In-65	0h1541	P1 terminal function setting	0	None	1: Fx	X	O
			1	Fx			
In-66	0h1542	P2 terminal function setting	2	Rx	2: Rx	X	O
			3	RST			
In-67	0h1543	P3 terminal function setting	4	External trip	5: BX	X	O
			5	BX			
In-68	0h1544	P4 terminal function setting	6	JOG	3: RST	X	O
			7	Speed-L			
In-69	0h1545	P5 terminal function setting	8	Speed-M	7: Sp-L	X	O
			9	Speed-H			

•  In the following table, data shaded in blue will be displayed when the related code has been selected.

• SL: Sensorless vector control (dr.09), Property: Write-enabled during operation

<sup>29)</sup> Displayed when In.06 is set to 1 (Bipolar).

<sup>30)</sup> Quantizing is not used when set to 0.

Code	Comm. Address	Name	Setting Range	Initial Value	Property*	V/F	SL
-	-	-	11	XCEL-L	-	-	-
			12	XCEL-M			
			13	RUN enable			
			14	3-Wire			
			15	2nd source			
			16	Exchange			
			17	Up			
			18	Down			
			20	U / D Clear			
			21	Analog hold			
			22	I-Term clear			
			23	PID Openloop			
			24	P Gain2			
			25	XCEL stop			
			26	2nd motor			
			27	U / D Enable			
			33	Baseblock			
			34	Pre excite			
			38	Timer in			
			40	dis Aux ref			
			46	FWD JOG			
			47	REV JOG			
			49	XCEL-H			
51	Fire mode						
52	KEB-1 Select						
In-84	0h1554	Multi-function input terminal on filter selection	P5 - P1		1 1111 <sup>31)</sup>	O	O
			0	Disable(Off)			
			1	Enable(On)			
In-85	0h1555	Multi-function input terminal on filter	0~10000(ms)		10	O	O
In-86	0h1556	Multi-function input terminal off filter	0~10000(ms)		3	O	O
In-87	0h1557	Multi-function input terminal selection	P5 - P1		0 0000 <sup>32)</sup>	X	O
			0	A contact (NO)			
			1	B contact (NC)			
In-88	0h1558	Selects the NO / NC operation command	0	NO	0	X	O
			1	NO/NC			
In-89	0h1559	Multi-step command delay time	1-5000(ms)		1	X	O
In-90	0h155A	Multi-function input terminal status	P5 - P1		0 0000	-	O
			0	release(Off)			
			1	Connection (On)			
In-99	0h1563	SW1(NPN/PNP), status	Bit	0~1	0	-	O
			0	NPN			
			1	PNP			

• SL: Sensorless vector control (dr.09), Property: Write-enabled during operation

<sup>31)</sup> The initial value 11111 will be displayed on the keypad as .

<sup>32)</sup> The initial value 0000 will be displayed on the keypad as .

Code	Comm.Address	Name	Setting Range	Initial Value	Property*	V/F	SL	
OU-00	-	Jump code	1~99	30	0	0	0	
OU-01	0h1601	Analog output 1 item	0	Frequency	0: Frequency	0	0	0
			1	Output current				
			2	Output voltage				
			3	DCLink voltage				
			4	Torque				
			5	Output power				
			6	Idse				
			7	Iqse				
			8	Target freq				
			9	Ramp freq				
			10	Speed fdb				
			12	PID ref value				
			13	PID fdb value				
			14	PID output				
			15	Constant				
OU-02	0h1602	Analog output 1 gain	-1000.0~1000.0(%)	100.0	0	0	0	
OU-03	0h1603	Analog output 1 bias	-100~100(%)	0	0	0	0	
OU-04	0h1604	Analog output 1 filter	0~10000(ms)	5	0	0	0	
OU-05	0h1606	Analog constant output 1	0.0~100.0(%)	0.0	0	0	0	
OU-06	0h1606	Analog output 1 monitor	0.0~1000.0(%)	0.0	-	0	0	
OU-30	0h161E	Fault output item	bit	000~111	010 <sup>33)</sup>	0	0	0
			1	Low voltage				
			2	Any faults other than low voltage				
			3	Final failure of automatic restart				
OU-31	0h161F	Multi-function relay 1 item	0	None	29: Trip	0	0	0
			1	FDT-1				
			2	FDT-2				
			3	FDT-3				
			4	FDT-4				
			5	Over load				
			6	IOL				
			7	Under load				
			8	Fan warning				
			9	Stall				
			10	Over voltage				
			11	Low voltage				
			12	Over heat				
			13	Lost command				
			14	Run				
15	Stop							

\* SL: Sensorless vector control (dr.09), Property: Write-enabled during operation

<sup>33)</sup> The initial value 0000 will be displayed on the keypad as .

Code	Comm.Address	Name	Setting Range	Initial Value	Property*	V/F	SL	
OU-31	0h161F	Multi-function relay 1 item	16	Steady	29: Trip	0	0	0
			17	Inverter line				
			18	Comm line				
			19	Speed search				
			21	Regeneration				
			22	Ready				
			23	Zero speed				
			28	Timer out				
			29	Trip				
			31	DB Warn%ED				
			34	On / Off control				
			35	BR control				
			36	Reserved				
			37	FAN exchange				
			38	Fire mode				
			40	KEB operating				
			41	Pre overheat				
42	Minor fault							
43	Torque detect 1							
44	Torque detect 2							
OU-33	0h1621	Multi-function relay 2 item	0	None	14: Run	0	0	0
			1	FDT-1				
			2	FDT-2				
			3	FDT-3				
			4	FDT-4				
			5	Over load				
			6	IOL				
			7	Under load				
			8	Fan warning				
			9	Stall				
			10	Over voltage				
			11	Low voltage				
			12	Over heat				
			13	Lost command				
			14	Run				
			15	Stop				
			16	Steady				
17	Inverter line							
18	Comm line							
19	Speed search							
21	Regeneration							
22	Ready							
23	Zero speed							

\* SL: Sensorless vector control (dr.09), Property: Write-enabled during operation

Code	Comm.Address	Name	Setting Range	Initial Value	Property*	V/F	SL	
OU-33	0h1621	Multi-function relay 2 item	28	Timer out	14: Run	O	O	O
			29	Trip				
			31	DB Warn%ED				
			34	On / Off control				
			35	BR Control				
			36	Reserved				
			37	FAN Exchange				
			38	Fire mode				
			40	KEB Operating				
			41	Pre overheat				
			42	Minor fault				
			43	Torque detect 1				
			44	Torque detect 2				
OU-41	0h1629	Multi-function output monitor	-	00	-	-	-	
OU-50	0h1632	Multi-function output on delay	0.00~100.00(s)	0.00	O	O	O	
OU-51	0h1633	Multi-function output off delay	0.00~100.00(s)	0.00	O	O	O	
OU-52	0h1634	Multi-function output contact selection	Relay2, Relay1		00 <sup>34)</sup>	X	O	O
			0	A contact (NO)				
			1	B contact (NC)				
OU-53	0h1635	Fault output on delay	0.00~100.00(s)	0.00	O	O	O	
OU-54	0h1636	Fault output off delay	0.00~100.00(s)	0.00	O	O	O	
OU-55	0h1637	Timer on delay	0.00~100.00(s)	0.00	O	O	O	
OU-56	0h1638	Timer off delay	0.00~100.00(s)	0.00	O	O	O	
OU-57	0h1639	Detection frequency	0.00-Maximum frequency(Hz)	30.00	O	O	O	
OU-58	0h163A	Detection frequency band	0.00-Maximum frequency(Hz)	10.00	O	O	O	
OU-67 <sup>35)</sup>	0h1643	Torque detection 1 setting	0	None	0	X	O	O
			1	OT cmdspd warn				
			2	OT warning				
			3	OT cmdspdtrip				
			4	OT trip				
			5	UT cmdspd warn				
			6	UT warning				
			7	UT cmdspd trip				
			8	UT trip				
OU-68	0h1644	Torque detection 1 level	0~200.0 (%)	100	X	O	O	
OU-69	0h1645	Torque detection 1 delay time	0.0~10.0 (s)	0.1	X	O	O	
OU-70 <sup>36)</sup>	0h1646	Torque detection 1 setting	0	None	0	X	O	O
			1	OT cmdspd warn				
			2	OT warning				
			3	OT cmdspdtrip				
			4	OT trip				
			5	UT cmdspd warn				
			6	UT warning				
			7	UT cmdspd trip				
			8	UT trip				
OU-71	0h1647	Torque detection 2 level	0~200.0 (%)	100	X	O	O	
OU-72	0h1648	Torque detection 2 delay time	0.0~10.0 (s)	0.1	X	O	O	

\* SL: Sensorless vector control (dr.09), Property: Write-enabled during operation

<sup>34)</sup> The initial value 0000 will be displayed on the keypad as .

<sup>35)</sup> Displayed when OU.31,33 is set to 43 (Prt Trq Det1).

<sup>36)</sup> Displayed when OU.31,33 is set to 44 (Prt Trq Det2).

# Communication Function Group (PAR → CM)

General Drive

Code	Comm.Address	Name	Setting Range	Initial Value	Property*	V/F	SL
CM-00	-	Jump code	1~99	20	0	0	0
CM-01	0h1701	Built-in communication inverter ID	1~250	1	0	0	0
CM-02	0h1702	Built-in communication protocol	0	Modbus RTU	0: Modbus RTU	0	0
			2	LS Inv 485			
CM-03	0h1703	Built-in communication speed	0	1200 bps	3: 9600 bps	0	0
			1	2400 bps			
			2	4800 bps			
			3	9600 bps			
			4	19200 bps			
			5	38400 bps			
			6	56 Kbps			
CM-04	0h1704	Built-in communication frame setting	0	D8 / PN / S1	0: D8 / PN / S1	0	0
			1	D8 / PN / S2			
			2	D8 / PE / S1			
			3	D8 / PO / S1			
CM-05	0h1705	Transmission delay after reception	0~1000(ms)	5ms	0	0	0
CM-06 <sup>38)</sup>	0h1706	Communication option S/W version	-	0.00	0	0	0
CM-07 <sup>38)</sup>	0h1707	Communication option inverter ID	0~255	1	0	0	0
CM-08 <sup>38)</sup>	0h1708	Field bus communication speed	-	12Mbps	-	0	0
CM-09 <sup>38)</sup>	0h1709	Communication option LED status	-	-	0	0	0
CM-30	0h171E	Number of output parameters	0~8	3	0	0	0
CM-31	0h171F	Output communication address 1	0000~FFFF Hex	000A	0	0	0
CM-32	0h1720	Output communication address 2	0000~FFFF Hex	000E	0	0	0
CM-33	0h1721	Output communication address 3	0000~FFFF Hex	000F	0	0	0
CM-34	0h1722	Output communication address 4	0000~FFFF Hex	0000	0	0	0
CM-35	0h1723	Output communication address 5	0000~FFFF Hex	0000	0	0	0
CM-36	0h1724	Output communication address 6	0000~FFFF Hex	0000	0	0	0
CM-37	0h1725	Output communication address 7	0000~FFFF Hex	0000	0	0	0
CM-38	0h1726	Output communication address 8	0000~FFFF Hex	0000	0	0	0
CM-50	0h1732	Number of input parameters	0~8	2	0	0	0
CM-51	0h1733	Input communication address 1	0000~FFFF Hex	0005	X	0	0
CM-52	0h1734	Input communication address 2	0000~FFFF Hex	0006	X	0	0
CM-53	0h1735	Input communication address 3	0000~FFFF Hex	0000	X	0	0
CM-54	0h1736	Input communication address 4	0000~FFFF Hex	0000	X	0	0
CM-55	0h1737	Input communication address 5	0000~FFFF Hex	0000	X	0	0
CM-56	0h1738	Input communication address 6	0000~FFFF Hex	0000	X	0	0
CM-57	0h1739	Input communication address 7	0000~FFFF Hex	0000	X	0	0
CM-58	0h173A	Input communication address 8	0000~FFFF Hex	0000	X	0	0
CM-68	0h1744	Field bus data swap	0	No	0	X	0
			1	Yes			
CM-70	0h1746	Communication multi-function input 1	0	None	0: None	0	0

•  In the following table, data shaded in blue will be displayed when the related code has been selected.

• SL: Sensorless vector control (dr.09), Property: Write-enabled during operation

<sup>37)</sup> 115200bps

<sup>38)</sup> Displayed only when a communication option card is installed.

Code	Comm.Address	Name	Setting Range		Initial Value	Property*	V/F	SL
CM-71	0h1747	Communication multi-function input 2	1	Fx	0: None	0	0	0
CM-72	0h1748	Communication multi-function input 3	2	Rx	0: None	0	0	0
CM-73	0h1749	Communication multi-function input 4	3	RST	0: None	0	0	0
CM-74	0h174A	Communication multi-function input 5	4	External trip	0: None	0	0	0
CM-75	0h174B	Communication multi-function input 6	5	BX	0: None	0	0	0
CM-76	0h174C	Communication multi-function input 7	6	JOG	0: None	0	0	0
CM-77	0h174D	Communication multi-function input 8	7	Speed-L	0: None	0	0	0
			8	Speed-M				
			9	Speed-H				
			11	XCEL-L				
			12	XCEL-M				
			13	Run enable				
			14	3-wire				
			15	2nd source				
			16	Exchange				
			17	Up				
			18	Down				
			20	U / D clear				
			21	Analog hold				
			22	I-term clear				
			23	PID openloop				
			24	P gain2				
			25	XCEL stop				
			26	2nd motor				
			27	U / D enable				
			33	Baseblock				
34	Pre excite							
38	Timer in							
40	Dis Aux ref							
46	FWD JOG							
47	REV JOG							
49	XCEL-H							
51	Fire mode							
52	KEB-1 select							
CM-86	0h1756	Communication multi-function input monitoring	-		0	X	0	0
CM-90	0h175A	Selection of data frame communication monitor	0	Int485	0	0	0	0
			1	Keypad				
CM-91	0h175B	Rev data frame count	0~65535		-	X	0	0
CM-92	0h175C	Err data frame count	0~65535		-	X	0	0
CM-93	0h175D	NAK data frame count	0~65535		-	X	0	0
CM-94 <sup>39)</sup>	-	Communication data upload	0	No	0: No	X	0	0
			1	Yes				

•  In the following table, data shaded in blue will be displayed when the related code has been selected.

• SL: Sensorless vector control (dr.09), Property: Write-enabled during operation

<sup>39)</sup> Displayed only when a communication option card is installed.

# Application Function Group (PAR → AP)

General Drive

Code	Comm.Address	Name	Setting Range	Initial Value	Property*	V/F	SL
AP-00	-	Jump code	1~99	20	O	O	O
AP-01	0h1801	Application function selection	0	None	0: None	X	O
			1	-			
			2	Proc PID			
AP-16 <sup>40)</sup>	0h1810	PID output monitor	(%)	0.00	-	O	O
AP-17 <sup>40)</sup>	0h1811	PID reference monitor	(%)	50.00	-	O	O
AP-18 <sup>40)</sup>	0h1812	PID feedback monitor	(%)	0.00	-	O	O
AP-19 <sup>40)</sup>	0h1813	PID reference setting	-100.00~100.00(%)	50.00	O	O	O
AP-20 <sup>40)</sup>	0h1814	PID reference source	0	Keypad	0: Keypad	X	O
			1	V1			
			3	V0			
			4	I2			
			5	Int 485			
			6	Fieldbus			
AP-21 <sup>40)</sup>	0h1815	PID feedback source	0	V1	0: V1	X	O
			2	V0			
			3	I2			
			4	Int 485			
			6	Fieldbus			
AP-22 <sup>40)</sup>	0h1816	PID controller proportional gain	0.0~1000.0(%)	50.0	O	O	O
AP-23 <sup>40)</sup>	0h1817	PID controller integral time	0.0~200.0(s)	10.0	O	O	O
AP-24 <sup>40)</sup>	0h1818	PID controller differentiation time	0~1000(ms)	0	O	O	O
AP-25 <sup>40)</sup>	0h1819	PID controller feed-forward compensation gain	0.0~1000.0(%)	0.0	O	O	O
AP-26 <sup>40)</sup>	0h181A	Proportional gain scale	0.0~100.0(%)	100.0	X	O	O
AP-27 <sup>40)</sup>	0h181B	PID output filter	0~10000(ms)	0	O	O	O
AP-28 <sup>40)</sup>	0h181C	PID Mode	0	Process PID	0	X	O
			1	Normal PID			
AP-29 <sup>40)</sup>	0h181D	PID upper limit frequency	PID lower limit frequency-300.00(Hz)	60.00	O	O	O
AP-30 <sup>40)</sup>	0h181E	PID lower limit frequency	-300.00-PID upper limit frequency(Hz)	-60.00	O	O	O
AP-32 <sup>40)</sup>	0h1820	PID output scale	0.1~1000.0(%)	100.0	X	O	O
AP-33 <sup>40)</sup>	0h181F	PID output inverse	0	No	0: No	X	O
			1	Yes			
AP-34 <sup>40)</sup>	0h1822	PID controller motion frequency	0.00-Maximum frequency(Hz)	0.00	X	O	O
AP-35 <sup>40)</sup>	0h1823	PID controller motion level	0.0~100.0(%)	0.0	X	O	O
AP-36 <sup>40)</sup>	0h1824	PID controller motion delay time	0~9999(s)	600	O	O	O
AP-37 <sup>40)</sup>	0h1825	PID sleep mode delay time	0.0~999.9(s)	60.0	O	O	O
AP-38 <sup>40)</sup>	0h1826	PID sleep mode frequency	0.00-Maximum frequency(Hz)	0.00	O	O	O
AP-39 <sup>40)</sup>	0h1827	PID wake-up level	0~100(%)	35	O	O	O
AP-40 <sup>40)</sup>	0h1828	PID wake-up mode setting	0	Below level	0: Below level	O	O
			1	Above level			
			2	Beyond level			

•  In the following table, data shaded in blue will be displayed when the related code has been selected.

• SL: Sensorless vector control (dr.09), Property: Write-enabled during operation

<sup>40)</sup> Displayed when AP.01 is set to 2 (Proc PID).

Code	Comm.Address	Name	Setting Range	Initial Value	Property*	V/F	SL	
AP-42 <sup>40)</sup>	0h182A	PID controller unit selection	0	%	0: %	O	O	O
			1	Bar				
			2	mBar				
			3	Pa				
			4	kPa				
			5	Hz				
			6	Rpm				
			7	V				
			8	I				
			9	kW				
			10	HP				
			11	°C				
			12	°F				
AP-43 <sup>40)</sup>	0h182B	PID unit gain	0.00~300.00(%)	100.00	O	O	O	
AP-44 <sup>40)</sup>	0h182C	PID unit scale	0	x100	2: x 1	O	O	O
			1	x10				
			2	x 1				
			3	x 0.1				
			4	x 0.01				
AP-45 <sup>40)</sup>	0h182D	PID 2nd proportional gain	0.0~1000.0(%)	100.0	X	O	O	

•  In the following table, data shaded in blue will be displayed when the related code has been selected.

• SL: Sensorless vector control (dr.09), Property: Write-enabled during operation

<sup>40)</sup> Displayed when AP.01 is set to 2 (Proc PID).

# Protection Function Group (PAR → Pr)

General Drive

Code	Comm.Address	Name	Setting Range	Initial Value	Property*	V/F	SL
Pr-00	-	Jump code	1~99	40	O	O	O
Pr-04	0h1B04	Load level setting	0	Normal duty	1: Heavy duty	X	O
			1	Heavy duty			
Pr-05	0h1B05	Input / Output open-phase protection	bit	00~11	00 <sup>41)</sup>	X	O
			01	Output open phase			
			10	Input open phase			
Pr-06	0h1B06	Input voltage range during open-phase	1~100(V)	15	X	O	O
Pr-07	0h1B07	Deceleration time at fault trip	0.0~600.0(s)	3.0	O	O	O
Pr-08	0h1B08	Selection of startup on trip reset	0	No	0: No	O	O
			1	Yes			
Pr-09	0h1B09	Number of automatic restarts	0~10	0	O	O	O
Pr-10 <sup>42)</sup>	0h1B0A	Automatic restart delay time	0.0~60.0(s)	1.0	O	O	O
Pr-12	0h1B0C	Motion at speed command loss	0	None	0: None	O	O
			1	Free-run			
			2	Dec			
			3	Hold input			
			4	Hold output			
			5	Lost preset			
Pr-13 <sup>43)</sup>	0h1B0D	Time to determine speed command loss	0.1~120(s)	1.0	O	O	O
Pr-14 <sup>43)</sup>	0h1B0E	Operation frequency at speed command loss	0, Start frequency-maximum frequency(Hz)	0.00	O	O	O
Pr-15 <sup>43)</sup>	0h1B0F	Analog input loss decision level	0	Half of x1	0: Half of x1	O	O
			1	Below x1			
Pr-17	0h1B11	Overload warning selection	0	No	0: No	O	O
			1	Yes			
Pr-18	0h1B12	Overload warning level	30~180(%)	150	O	O	O
Pr-19	0h1B13	Overload warning time	0.0~30.0(s)	10.0	O	O	O
Pr-20	0h1B14	Motion at overload fault	0	None	1: Free-run	O	O
			1	Free-run			
			2	Dec			
Pr-21	0h1B15	Overload fault level	30~200(%)	180	O	O	O
Pr-22	0h1B16	Overload fault time	0.0~60.0(s)	60.0	O	O	O
Pr-25	0h1B19	Under load warning selection	0	No	0: No	O	O
			1	Yes			
Pr-26	0h1B1A	Under load warning time	0.0~600.0(s)	10.0	O	O	O
Pr-27	0h1B1B	Under load fault selection	0	None	0: None	O	O
			1	Free-run			
			2	Dec			
Pr-28	0h1B1C	Under load fault time	0.0~600.0(s)	30.0	O	O	O
Pr-29	0h1B1D	Under load lower limit level	10~100(%)	30	O	O	O

•  In the following table, data shaded in blue will be displayed when the related code has been selected.

• SL: Sensorless vector control (dr.09), Property: Write-enabled during operation

<sup>41)</sup> The initial value 0000 will be displayed on the keypad as .

<sup>42)</sup> Displayed when Pr.09 is set higher than 0.

<sup>43)</sup> Displayed when Pr.12 is not set to 0 (NONE).

Code	Comm.Address	Name	Setting Range	Initial Value	Property*	V/F	SL
Pr-30	0h1B1E	Under load upper limit level	10~100(%)	30	O	O	O
Pr-31	0h1B1F	No motor motion at detection	0	None	0: None	O	O
			1	Free-run			
Pr-32	0h1B20	No motor detection current level	1~100(%)	5	O	O	O
Pr-33	0h1B21	No motor detection time	0.1~10.0(s)	3.0	O	O	O
Pr-40	0h1B28	Electronic thermal fault selection	0	None	0: None	O	O
			1	Free-run			
			2	Dec			
Pr-41	0h1B29	Motor cooling fan type	0	Self-cool	0: Self-cool	O	O
			1	Forced-cool			
Pr-42	0h1B2A	Electronic thermal 1 minute rating	120~200(%)	150	O	O	O
Pr-43	0h1B2B	Electronic thermal continuous rating	50~150(%)	120	O	O	O
Pr-45	0h1B2D	BX trip mode	0	Free-run	0	X	O
			1	Dec			
Pr-50	0h1B32	Stall prevention motion and flux braking	bit	0000~1111	0000	X	O
			0001	Accelerating			
			0010	At constant speed			
			0100	Decelerating			
			1000	Fluxbraking			
Pr-51	0h1B33	Stall frequency 1	Start frequency-stall frequency2(Hz)	60.00	O	O	X
Pr-52	0h1B34	Stall level 1	30~250(%)	180	X	O	X
Pr-53	0h1B35	Stall frequency 2	Start frequency1-stall frequency2(Hz)	60.00	O	O	X
Pr-54	0h1B36	Stall level 2	30~250(%)	180	X	O	X
Pr-55	0h1B37	Stall frequency 3	Start frequency2-stall frequency4(Hz)	60.00	O	O	X
Pr-56	0h1B38	Stall level 3	30~250(%)	180	X	O	X
Pr-57	0h1B39	Stall frequency 4	Stall frequency3-maximum frequency(Hz)	60.00	O	O	X
Pr-58	0h1B3A	Stall level 4	30~250(%)	180	X	O	X
Pr-59	0h1B3B	Flux braking gain value	0~150[%]	0	O	O	O
Pr-66	0h1B42	DB resistor warning level	0~30(%)	10	O	O	O
Pr-77	0h1B4D	Pre-overheat warning temperature	90~110	90	O	O	O
Pr-78	0h1B4E	Pre-overheat warning operation selection	0	None	0	O	O
			1	Warning			
			2	Freerun			
			3	Dec			
Pr-79	0h1B4F	Cooling fan fault selection	0	Trip	1: Warning	O	O
			1	Warning			
Pr-80	0h1B50	Motion selection at option trip	0	None	1: Free-run	O	O
			1	Free-run			
			2	Dec			
Pr-81	0h1B51	Low voltage fault decision delay time	0.0~60.0(s)	0.0	X	O	O
Pr-82	0h1B52	LV2 Selection	0	No	0	X	O
			1	Yes			
Pr-86	0h1B56	Accumulated percent of fan usage	0.0~100.0[%]	0.0	-	O	O
Pr-87	0h1B57	Fan exchange warning level	0.0~100.0[%]	90.0	O	O	O

\* SL: Sensorless vector control (dr.09), Property: Write-enabled during operation

Code	Comm.Address	Name	Setting Range		Initial Value	Property*	V/F	SL
Pr-88	0h1B58	Fan reset time	0	No	0	X	0	0
			1	Yes				
Pr-89	0h1B59	Fan status	Bit	00~01	0	-	0	0
			00	-				
			01	Fan exchange				
Pr-90	0h1B5A	Relay open trip selection	-		-	X	0	0
Pr-91	0h1B5B	Fault history 1	-		-	-	0	0
Pr-92	0h1B5C	Fault history 2	-		-	-	0	0
Pr-93	0h1B5D	Fault history 3	-		-	-	0	0
Pr-94	0h1B5E	Fault history 4	-		-	-	0	0
Pr-95	0h1B5F	Fault history 5	-		-	-	0	0
Pr-96	0h1B60	Fault history deletion	0	No	0: No	0	0	0
			1	Yes				

\*SL: Sensorless vector control (dr.09), Property: Write-enabled during operation

Code	Comm.Address	Name	Setting Range	Initial Value	Property*	V/F	SL	
M2-00	-	Jump code	1~99	14	O	O	O	
M2-04	0h1C04	Acceleration time	0.0~600.0(s)	20.0	O	O	O	
M2-05	0h1C05	Deceleration time	0.0~600.0(s)	30.0	O	O	O	
M2-06	0h1C06	Motor capacity	0	0.2 kW	-	X	O	O
			1	0.4 kW				
			2	0.75 kW				
			3	1.1 kW				
			4	1.5 kW				
			5	2.2 kW				
			6	3.0 kW				
			7	3.7 kW				
			8	4.0 kW				
			9	5.5 kW				
			10	7.5 kW				
11	11.0kW							
M2-07	0h1C07	Base frequency	30.00~400.00(Hz)	60.00	X	O	O	
M2-08	0h1C08	Control mode	0	V / F	0: V / F	X	O	O
			2	Slip compen				
			4	IM sensorless				
M2-10	0h1C0A	Number of motor poles	2~48	Dependent on motor setting	X	O	O	
M2-11	0h1C0B	Rated slip speed	0~3000(Rpm)		X	O	O	
M2-12	0h1C0C	Motor rated current	1.0~1000.0(A)		X	O	O	
M2-13	0h1C0D	Motor no-load current	0.5~1000.0(A)		X	O	O	
M2-14	0h1C0E	Motor rated voltage	170~480(V)		X	O	O	
M2-15	0h1C0F	Motor efficiency	64~100(%)		X	O	O	
M2-16	0h1C10	Load inertia rate	0~8		X	O	O	
M2-17	-	Stator resistance	Dependent on motor setting		X	O	O	
M2-18	-	Leakage inductance			X	O	O	
M2-19	-	Stator inductance			X	O	O	
M2-20 <sup>44)</sup>	-	Rotor time constant		25~5000(ms)	X	O	O	
M2-25	0h1C19	V / F pattern	0	Linear	0: Linear	X	O	O
			1	Square				
			2	User V / F				
M2-26	0h1C1A	Forward torque boost	0.0~15.0(%)	2.0	X	O	O	
M2-27	0h1C1B	Reverse torque boost	0.0~15.0(%)		X	O	O	
M2-28	0h1C1C	Stall prevention level	30~150(%)	150	X	O	O	
M2-29	0h1C1D	Electronic thermal 1 minute rating	100~200(%)	150	X	O	O	
M2-30	0h1C1E	Electronic thermal continuous rating	50-Electronic thermal 1 minute rating	100	X	O	O	
M2-31	0h1C1F	Low-speed torque compensation gain	50~300(%)	Varies by motor capacity	X	X	O	

•  In the following table, data shaded in blue will be displayed when the related code has been selected.

• The 2nd Motor function group will be displayed if any of In.65-71 is set to 26 (2nd motor).

• SL: Sensorless vector control (dr.09), Property: Write-enabled during operation

<sup>44)</sup> Displayed when M2.08 is set to 4(IM Sensorless).

Code	Comm.Address	Name	Setting Range	Initial Value	Property*	V/F	SL
M2-32	0h1C20	Output torque compensation gain	50~300(%)	Varies by motor capacity	X	X	O
M2-33	0h1C21	Speed deviation sub compensation gain	50~300(%)	Varies by motor capacity	X	X	O
M2-34	0h1C12	Speed deviation main compensation gain	50~300(%)	Varies by motor capacity	X	X	O
M2-40	0h1C28	Rotation count speed gain	0.1~6000.0[%]	100.0	O	O	O
M2-41	0h1C29	Rotation count speed scale	0	x 1	0: x 1	O	O
			1	x 0.1			
			2	x 0.01			
			3	x 0.001			
			4	x 0.0001			
M2-42	0h1C2A	Rotation count speed unit	0	Rpm	0: rpm	O	O
			1	mpm			

- The 2nd Motor function group will be displayed if any of In.65-71 is set to 26 (2nd motor).
- SL: Sensorless vector control (dr.09), Property: Write-enabled during operation

## Braking Resistor Specification

Capacity(kW)		Resistance(Ω)		Rated Capacity(W)	
3-Phase 200V Class	0.4	300		100	
	0.75	150		150	
	1.5	60		300	
	2.2	50		400	
	3.7	33		600	
	4	33		600	
	5.5	20		800	
	7.5	15		1200	
3-Phase 400V Class	0.4	1200		100	
	0.75	600		150	
	1.5	300		300	
	2.2	200		400	
	3.7	130		600	
	4	130		600	
	5.5	85		1000	
	7.5	60		1200	

\* The standard for braking torque is 150% and the working rate (%ED) is 5%. If the working rate is 10%, the rated capacity for braking resistance must be calculated at twice the standard.

## Compatible Circuit Breaker, Leakage Breaker and Magnetic Contactor Models (Manufactured by LSIS)

Capacity(kW)		Circuit Breaker			Leakage Breaker		Magnetic Contactor	
		Model	Current(A)	Specific Model Name	Model	Current(A)	Model	Current(A)
3-Phase 200V Class	0.4	UTE100H	15	UTE100-H·FTU·15·3P·UL	EBS33c	5	MC-6a	9
	0.75						MC-9a, MC-9b	11
	1.5						MC-18a, MC-18b	18
	2.2						MC-22b	22
	4.0	MC-32a	32					
	5.5	UTS150H	50	UTS150-H·FTU·50·3P·UL	EBS53c	50	MC-50a	55
7.5	MC-65a						65	
3-Phase 400V Class	0.4	UTE100E	15	UTE100-E·FTU·15·3P·UL	EBS33c	5	MC-6a	7
	0.75						MC-6a	
	1.5						MC-9a, MC-9b	9
	2.2						MC-12a, MC-12b	12
	4.0	MC-18a, MC-18b	18					
	5.5	30	UTE100-E·FTU·30·3P·UL	30	MC-22b	22	MC-32a	32
7.5	MC-32a							

## Fuse and Reactor Specifications

Capacity (kW)		AC Input Fuse			AC Reactor			
		Model	Current (A)	Voltage (V)	Inductance (mH)	Current (A)		
3-Phase 200V Class	0.4	DFJ-10 1)	10	600	1.20	10		
	0.75							
	1.5						0.88	14
	2.2						0.56	20
	4.0						0.39	30
	5.5						0.30	34
	7.5						0.22	45
3-Phase 400V Class	0.4	DFJ-10	10	600	4.81	4.8		
	0.75							
	1.5						3.23	7.5
	2.2						2.34	10
	4.0						1.22	15
	5.5						1.12	19
7.5	0.78	27						

Note1) DFJ is class J / 600V level model name of the bussmann company.

**Caution** Use class CC, G, J, L, R or T UL listed Input fuse and UL listed breaker only. See the table above for the voltage and current rating of the fuse and the breaker.

Voltage	Model Number	Rated Power (kW)	HD				ND			
			Rated Output Current(A)	Total Losses(W)	Internal Losses(W)	Heat Losses (Kcal)	Rated Output Current(A)	Total Losses(W)	Internal Losses(W)	Heat Losses (Kcal)
220	LSLV0004G100-2	0.4	2.5	19	16.8	2	3.1	24	16.8	7
220	LSLV0008G100-2	0.75	5.0	34	16.8	14	6.0	37	16.8	17
220	LSLV0015G100-2	1.5	8.0	50	17.4	28	9.6	59	17.4	35
220	LSLV0022G100-2	2.2	11.0	80	17.4	54	12.0	89	17.4	62
220	LSLV0037G100-2	4.0	17.0	127	17.7	94	18.0	160	17.7	122
220	LSLV0055G100-2	5.5	24.0	173	18.7	132	30.0	267	18.7	214
220	LSLV0075G100-2	7.5	32.0	247	18.7	197	40.0	398	18.7	326
440	LSLV0004G100-4	0.4	1.3	21	17.4	3	2.0	22	17.4	4
440	LSLV0008G100-4	0.75	2.5	25	17.4	7	3.1	31	17.4	12
440	LSLV0015G100-4	1.5	4.0	40	17.7	19	5.1	47	17.7	25
440	LSLV0022G100-4	2.2	5.5	54	17.7	31	6.9	57	17.7	33
440	LSLV0037G100-4	4.0	9.0	93	18.7	64	10.0	125	18.7	91
440	LSLV0055G100-4	5.5	12.0	170	19.7	129	16.0	153	19.7	115
440	LSLV0075G100-4	7.5	16.0	194	19.7	149	23.0	225	19.7	177

**Total losses**

Capacity(kW) x (1-Efficiency/100) x 1000 = W  
 ex) 0.4kW x (1- 95.3/100) x 1000 = 18.8W  
 Total losses = Internal loss + External loss

**Internal losses**

Based on design standard such as SMPS Rated Capacity, Fan and so forth

**External(Heat) losses**

1wh = 3,600J, 1kcal = 4,186 J  
 Efficiency= Output/(Output+Loss)\*100=Output/Input\*100  
 Loss\*0.9=Heat Loss  
 -> Other Loss 0.1  
 Σ(The number of installed drive at each capacity\*Heat) = Total amount of Heat

**0.4~0.75kW** (0004G100-2, 0008G100-2, 0004G100-4, 0008G100-4)

Units: mm(Inches)

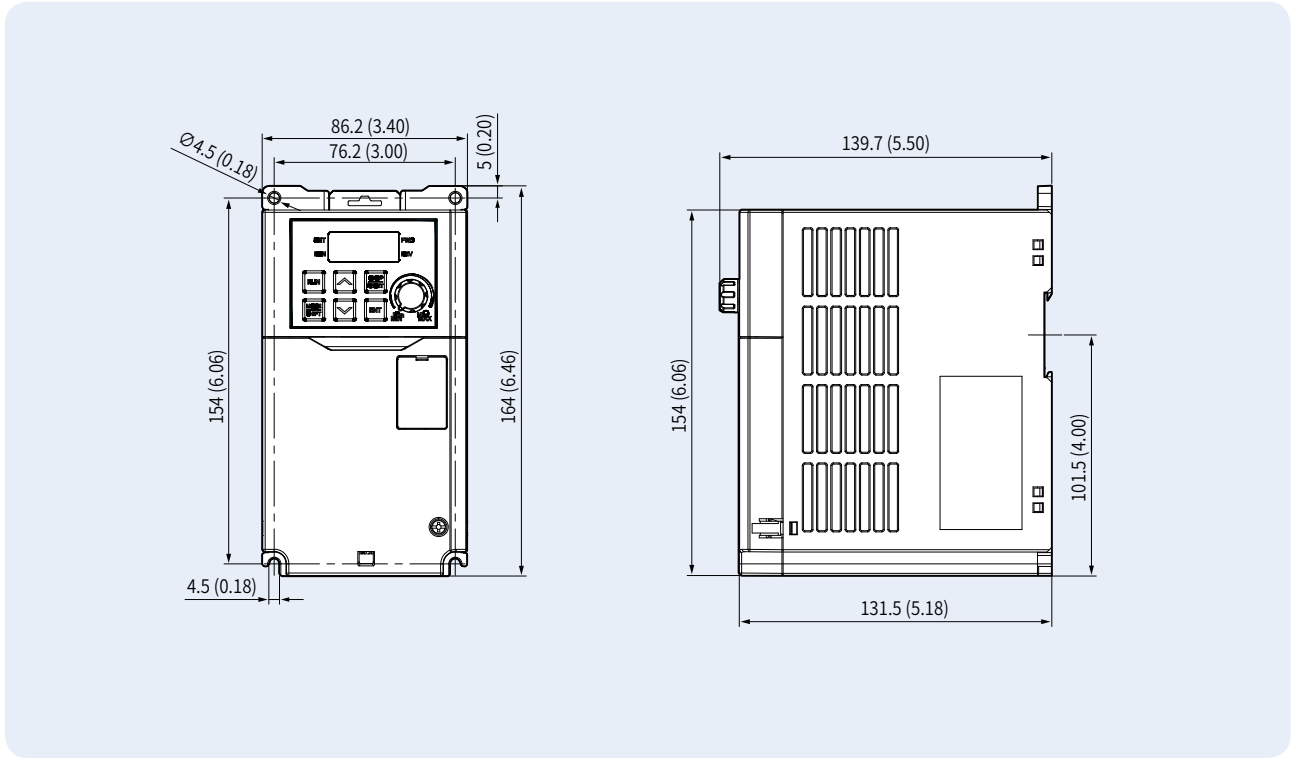

**1.5~2.2kW** (0015G100-2, 0022G100-2, 0015G100-4, 0022G100-4)

Units: mm(Inches)

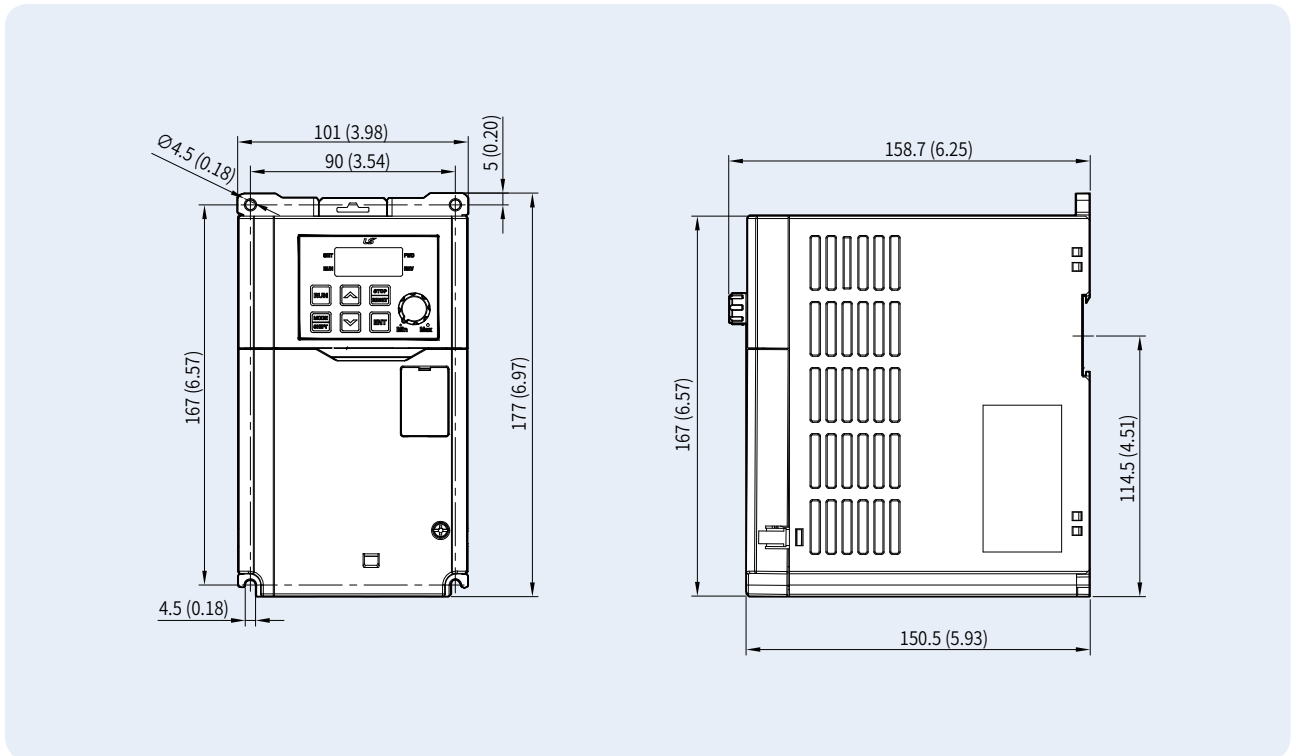

4.0kW (0040G100-2, 0040G100-4)

Units: mm(Inches)

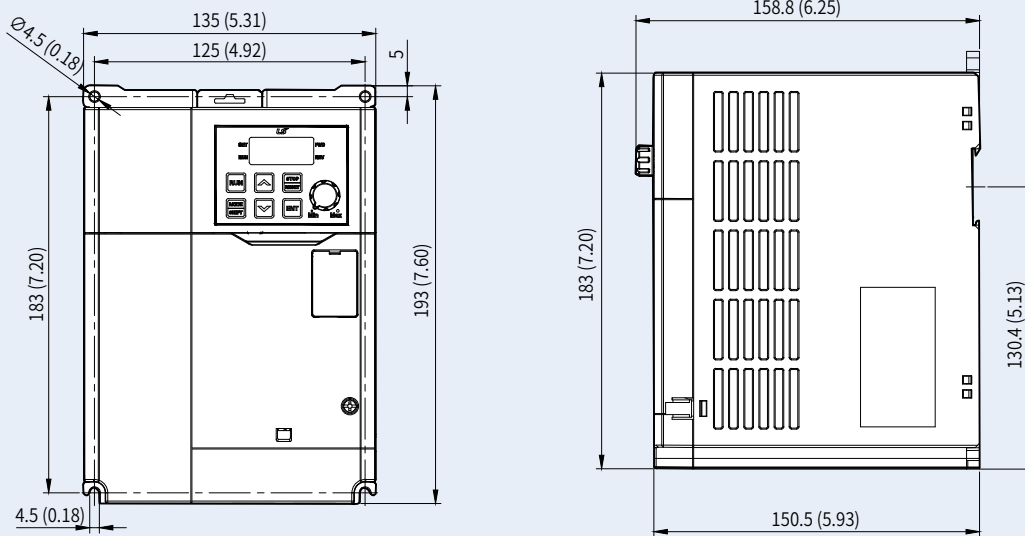

5.5~7.5kW (0055G100-2, 0075G100-2, 0055G100-4, 0075G100-4)

Units: mm(Inches)

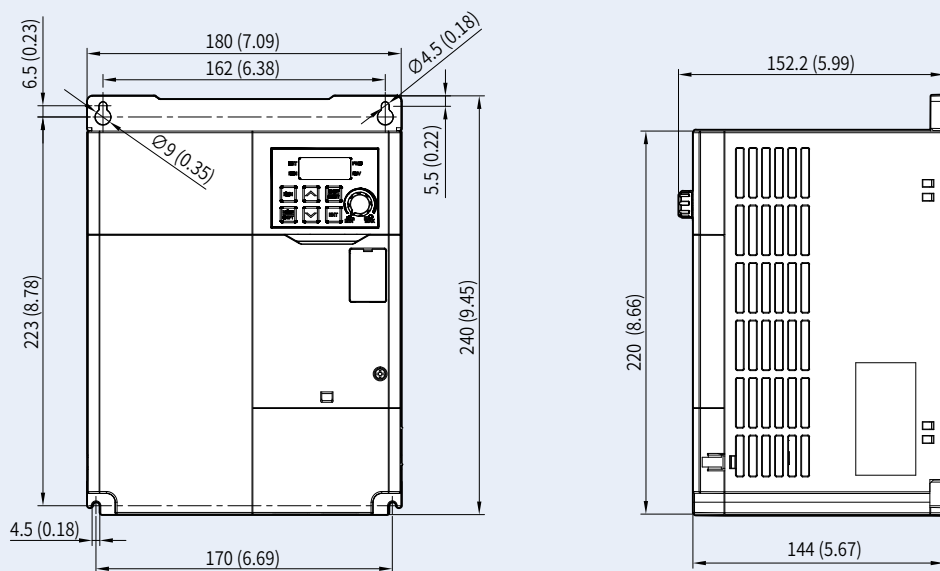

# Global Network

LSIS is engaged in business all over the world. LSIS global network includes 7 overseas corporations, 12 overseas branches, and 224 clients in 77 countries.



## ► R&D

## ► Factory



### R&D Campus

Focuses on gaining competitive advantages through development of next generation platforms



### Power Device R&D Center

Leading technology in electric industry and continuously developing future-growth dynamic engines



### Automation R&D Center

Serves as the main research institute for LSIS



### PT&T (Testing laboratory)

Internationally-renowned testing center that has formed partnerships with the UL, CE, KEMA and CESI



### Cheongju Factory (Korea)

Electric products, mold TR, MV/LV switchgear, HV GIS

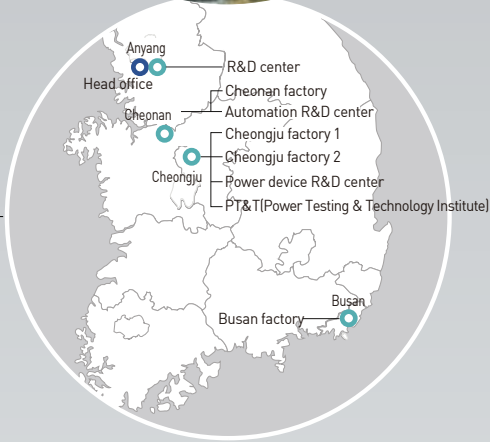

**Cheonan Factory** (Korea)

PLC, AC drive, HMI, DCS, PV module



**Busan Factory** (Korea)

HV TR, HVDC, FACTS



**Wuxi Factory** (China)

Electric products



**Dalian Factory** (China)

MV/LV switchgear, MV contactor



**Hanoi Factory** (Vietnam)

MV/LV switchgear, Mold TR



### Safety Instructions

- For your safety, please read user's manual thoroughly before operating.
- Contact the nearest authorized service facility for examination, repair, or adjustment.
- Please contact qualified service technician when you need maintenance. Do not disassemble or repair by yourself!
- Any maintenance and inspection shall be performed by the personnel having expertise concerned.



- According to The WEEE Directive, please do not discard the device with your household waste.



[www.lsis.com](http://www.lsis.com)

#### ■ Head Quarter

LS Yongsan Tower, 92, Hangang-daero, Yongsan-gu, Seoul, 04386, Korea  
Tel : 82-2-2034-4286 Fax : 82-2-2034-4648 E-mail : drivesales@lsis.com

#### ■ Overseas Subsidiaries

- **LSIS(Shanghai) Co., Ltd. /CHINA**  
Tel : 86-21-5237-9977(609) Fax : 86-21-5237-7189
- **LSIS(Dalian) Co., Ltd. (Dalian, China)**  
Tel: 86-411-8730-7510 Fax: 86-411-8730-7560 E-Mail: jiheo@lsis.com
- **LSIS(Wuxi) Co., Ltd. (Wuxi, China)**  
Tel: 86-510-8534-6666-8005 Fax: 86-510-8534-4078 E-Mail: sunhwank@lsis.com
- **LS VINA Industrial Systems Co., Ltd. (Hanoi, Vietnam)**  
Tel: 84-24-3882-0222 Fax: 84-24-3882-0220 E-Mail: jhchoi4@lsis.com
- **LSIS Middle East FZE (Dubai, U.A.E.)**  
Tel: 971-4-886-5360 Fax: 971-4-886-5361 E-Mail: hschoib@lsis.com
- **LSIS Europe B.V. (Hoofddorf, Netherlands)**  
Tel: 31-20-654-1420 Fax: 31-20-654-1429 E-Mail: htha@lsis.com
- **LSIS Japan Co., Ltd. (Tokyo, Japan)**  
Tel: 81-3-6268-8241 Fax: 81-3-6268-8240 E-Mail: jschuna@lsis.com
- **LSIS USA Inc. (Chicago, U.S.A.)**  
Tel: 1-800-891-2941 Fax: 1-847-383-6543 E-Mail: sales.us@lsis.com

#### ■ Overseas Branches

- **LSIS Shanghai Office (China)**  
Tel: 86-21-5237-9977(609) Fax: 86-21-5237-7189 E-Mail: ygeo@lsis.com

- **LSIS Beijing Office (China)**  
Tel: 86-10-5761-3127 Fax: 86-10-5761-3128 E-Mail: sson@lsis.com
- **LSIS Guangzhou Office (China)**  
Tel: 86-20-8326-6784 Fax: 86-20-8326-6287 E-Mail: sojhtrh@lsis.com
- **LSIS Qingdao Office (China)**  
Tel: 86-532-8501-6058 Fax: 86-532-8501-6057 E-Mail: sson@lsis.com
- **LSIS Chengdu Office (China)**  
Tel: 86-28-8670-3200 Fax: 86-28-8670-3203 E-Mail: yangcf@lsis.com
- **LSIS ShenYang Office (China)**  
Tel: 86-24-2321-9050 Fax: 86-24-8386-7210 E-Mail: yangcf@lsis.com
- **LSIS Jinan Office (China)**  
Tel: 86-531-8699-7826 Fax: 86-531-8697-7628 E-Mail: yangcf@lsis.com
- **LSIS Co., Ltd. Tokyo Office (Japan)**  
Tel: 81-3-6268-8241 Fax: 81-3-6268-8240 E-Mail: jschuna@lsis.com
- **LSIS Co., Ltd. Rep. Office (Vietnam)**  
Tel: 84-28-3823-7890 E-Mail: sjbaik@lsis.com
- **LSIS Moscow Office (Russia)**  
Tel: 7-499-682-6130 E-Mail: jdpark1@lsis.com
- **LSIS Jakarta Office (Indonesia)**  
Tel: 62-21-2933-7614 E-Mail: dioh@lsis.com
- **LSIS Bangkok Office (Thailand)**  
Tel: 66-90-950-9683 E-Mail: sjleet@lsis.com